

OB-6

Operation Manual



Dave Smith
I N S T R U M E N T S

OB-6

Operation Manual

Version 1.0

March 2016

Dave Smith Instruments LLC
1527 Stockton Street, 3rd Floor
San Francisco, CA 94133
USA

©2016 Dave Smith Instruments LLC
www.davesmithinstruments.com



Tested To Comply
With FCC Standards
FOR OFFICE USE



This device complies with Part 15 of the FCC Rules. Operation is subject to the following two conditions: (1) This device may not cause harmful interference and (2) this device must accept any interference received, including interference that may cause undesired operation.

This Class B digital apparatus meets all requirements of the Canadian Interference-Causing Equipment Regulations.

Cet appareil numérique de la classe B respecte toutes les exigences du Règlement sur le matériel brouilleur du Canada.

For Technical Support, email: support@davesmithinstruments.com

Table of Contents

A Few Words of Thanks	ix
Getting Started.	1
Sound Banks	2
Selecting Programs	2
Editing Programs	3
Comparing an Edited Program to its Original State	3
Creating a Program from Scratch	4
Live Panel Mode	4
Saving a Program	5
Canceling Save	6
Moving to the Next Level	7
Connections.	8
Global Settings	10
Globals - Top Row	11
Globals - Bottom Row	12
Oscillators	15
Oscillator Parameters	16
Detune	18
Mixer.	19
Filter	20
Filter Envelope.	22
Changing the Filter Envelope's Response Curve	24
Loudness Envelope.	25
Effects.	27
Effects Parameters	29

Distortion	33
Low Frequency Oscillators	34
X-Mod	36
X-Mod Parameters	37
Arpeggiator Parameters	40
Sequencer	41
Programming the Sequencer	41
Sequencer Parameters	43
Portamento	47
Unison	48
Using Chord Memory	49
Write	51
Canceling Save	52
Comparing Before You Save	52
Globals	53
Manual	54
Pitch and Mod Wheels	55
Pitch Wheel	55
Modulation Wheel	56
Aftertouch	56
Exporting Programs and Banks	59
Calibrating the OB-6	60
How and When to Calibrate the Oscillators and Filters	60
Calibrating the Pitch and Mod Wheels	61
Resetting the Global Parameters	61

- Using USB62**

- Appendix A: Alternative Tunings63**

- Appendix B: Troubleshooting and Support67**
 - Troubleshooting 67
 - Contacting Technical Support 69
 - Warranty Repair 70

- Appendix C: MIDI Implementation71**
 - MIDI Messages 72
 - NRPN Messages 76
 - Control NRPN Data 80
 - Sysex Messages 80
 - Packed Data Format 83

Credits and Acknowledgements

Sound Design

Cyan Assiter-Clark, Daniel Davis, Peter Dyer, Peter Gorges, Tim Koon, Kurt Kurasaki, Kevin Lamb, Peter Mahr, Cord Mueller, Drew Neumann, Bob Oxley, Robert Rich, Matia Simovich, James Terris, Mitch Thomas, Taiho Yamada, Lorenz Rhode

The DSI Crew

Fabien Cesari, Bob Coover, Carson Day, Chris Hector, Tony Karavidas, Mark Kono, Justin Labreque, Andy Lambert, Andrew McGowan, Joanne McGowan, Tracy Wadley, and Mark Wilcox.

Special thanks to Tom Oberheim. Thanks also to Robert Rich for the alternative tunings content.

A Few Words of Thanks

Thank you for purchasing the OB-6. It's an awesome-sounding synthesizer and we're very proud of it, and I'm very proud to have been able to co-create it with my old friend, Tom Oberheim.

I've known Tom since the late 1970's when we both shared the heady experience of creating and selling some of the very first polyphonic synthesizers through our respective companies, Sequential Circuits and Oberheim Electronics. Back in those days, people were typically in either the Prophet or the Oberheim camp, and though we were competitors, we were always *friendly* competitors, and have remained good friends ever since.

Now, many years later, with the analog synth revival, Tom and I are again making the instruments that we love. After I reacquired the Sequential brand and released the Prophet-6 — and saw how much people liked it — the DSI gang and I thought it would be fun to work with Tom to help bring back his classic SEM-based polyphonic sound in a modern format. So we did. And the result is the very synth that you've just unboxed.

The OB-6 takes the best qualities of Tom's classic SEM-based synths and adds some nice touches that the originals never had, such as stereo outputs, velocity and after-touch sensitivity, dual digital effects, a polyphonic step sequencer, an arpeggiator, and of course, MIDI. The result is a modern classic: Pure vintage analog tone with the reliability of a state-of-the-art, modern instrument.

Working together to bring you the OB-6 has been a real pleasure. We hope you enjoy it and make some great music with it!

Cheers,

DAVE SMITH

Tom Oberheim

Getting Started

The OB-6 is a six-voice, polyphonic analog synthesizer with voltage-controlled oscillators, filters, and amplifiers. It was designed to provide all of the warmth, punch, and presence of a classic, SEM-based Tom Oberheim synthesizer, with the added convenience and stability of a state-of-the-art, modern instrument.

All of the sound-shaping controls of the OB-6 are accessible on its front panel, packing a tremendous amount of power and versatility into a compact, easy-to-use format.

Each of the OB-6's parameters are explained in later sections of this manual. But don't hesitate to dive right in and start turning knobs and pressing buttons before you begin reading. You can always get back to where you started, even if you have no idea what you're doing. So start exploring and keep your ears and mind open!

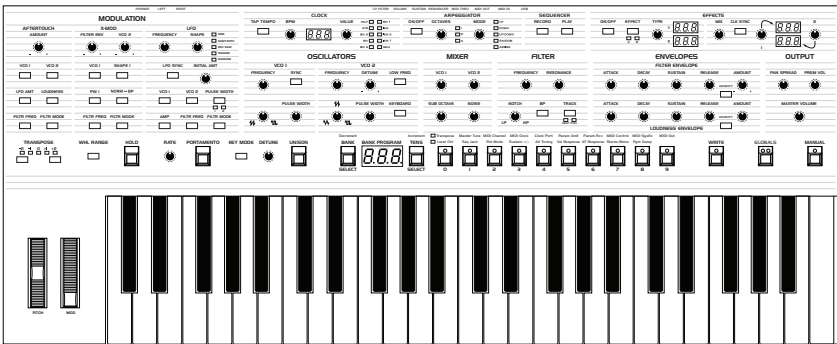

OB-6 front panel

Sound Banks

The OB-6 contains a total of 1000 programs. 500 are permanent and 500 can be overwritten. Banks 0-4 are User Banks that can be overwritten. Banks 5-9 are Factory Banks that are permanent. You can edit the programs of either bank, but you can only save them to Banks 0-4. As shipped from the factory, presets 000-499 are identical to 500-999.

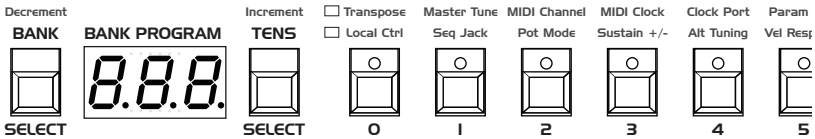

Program bank, tens, and number selectors

Selecting Programs

Use the BANK, TENS, and PROGRAM SELECTOR buttons to select and recall programs.

To choose a program:

1. Press a PROGRAM SELECTOR button (0-9) to specify the “ones” digit of the program.
2. Hold down the TENS button then press a PROGRAM SELECTOR button (0-9) to specify the “tens” digit of the program.
3. Hold down the BANK button then press a PROGRAM SELECTOR button (0-9) to specify the “hundreds” bank of the program.

To choose program 123, for example:

1. Hold BANK and press 1. Then release the BANK button.
2. Hold TENS and press 2. Then release the TENS button.
3. Press PROGRAM SELECTOR button 3.



Holding down the DECREMENT button and pressing the INCREMENT button advances the program number by 1 value. Conversely, holding down the INCREMENT button and pressing the DECREMENT button decrements the program number by 1 value. This is especially useful for going between Tens, as you can wrap around to the next set.

It's not always necessary to enter all 3 digits of a program number to recall it.

For example:

- If the current program is 100 and you want to recall program 101, simply press “1.”
- If the current program is 100 and you want to recall program 110, hold down the TENS button and press “1.”
- If the current program is 100 and you want to recall program 115, hold down the TENS button and press “1.” Then release the TENS button and press “5.”



Pressing the GLOBALS button three times in a row saves the current program as the default program that appears when you turn on the OB-6.

Editing Programs

Because all of the sound-shaping controls of the OB-6 appear on its front panel, editing an existing program is simple: just turn a knob and listen to its effect. Keep turning knobs and pressing buttons and if you like what you've created, save the program. (See “Saving a Program” on page 5.)



The rotary controls on the front panel are a mixture of “endless” rotary encoders and potentiometers or “pots.” You can choose between three different modes that determine how the synth reacts when parameters are edited with a pot. For details, see “Pot Mode” on page 13.

Comparing an Edited Program to its Original State

When editing a program, it's often useful to compare its edited state to its original state to evaluate your edits. Alternatively, before saving a program to a new location you may want to check the program in the target location before you overwrite it.

To compare an edited program to a saved version:

1. Edit a program.
2. Press the WRITE button. It starts flashing.

3. Press the GLOBAL button. Both LEDs on the button light up, indicating COMPARE mode.
4. Play the keyboard to hear the saved version of the sound.
5. To disable the compare function and return to the edited sound, turn off the GLOBAL button. Programs can't be written while in compare mode.
6. If you want to save the edited sound, the WRITE button is still flashing and ready to save, so enter a location with the PROGRAM SELECTOR buttons. The sound is saved.
7. Alternatively, if you want to cancel saving and continue editing, press the WRITE button. It stops flashing and saving is canceled.



When you're editing a preset, the OB-6 has a convenient way of indicating the programmed (saved) value for any knob parameter: Whenever you turn a knob and reach the saved value of the parameter, an LED dot in the main OB-6 display will illuminate.

Creating a Program from Scratch

An existing program can be very useful as a jumping off point for new sounds. But it's also useful (and educational) to create a new sound from scratch. The OB-6 makes this easy by providing a "Basic Preset" that you can quickly recall at any time. This preset is very simple, with a single oscillator as its basis.

To recall the Basic Preset:

1. Hold down the MANUAL button.
2. Press the WRITE button.

Live Panel Mode

The OB-6 also features a “live panel” mode in which its sound switches to the current settings of its knobs and buttons. In other words, the current preset is ignored and what you see on the front panel is what you hear. This is a great mode for learning, experimentation, and instant gratification.

To enter live panel mode:

- Press the **MANUAL** button to toggle it on. Note that you can’t change programs or banks with **MANUAL** on.

To return to preset mode:

- Press the **MANUAL** button again to toggle it off.

MANUAL



Toggling on the **MANUAL** button enables “live panel” mode



Be aware when entering live panel mode that the current settings of the OB-6 knobs and switches may be such that no sound is produced. This could be because the Mixer levels are all set to zero, or some other reason. See *Appendix B: Troubleshooting and Support* for a checklist that can help you identify the cause.

Saving a Program

If you’ve created a sound that you like, you’ll probably want to save it. Saving a program overwrites a previously saved program. Sound designers often save many incremental versions of a program as they continue to refine it. These intermediate versions often make good jumping off points for new sounds.

To save a program to the same preset location:

1. Press the **WRITE** button. Its LED begins blinking.
2. Press a **PROGRAM SELECTOR** button (0-9) to specify the “ones” digit of the program.
3. The **WRITE** button LED stops blinking and the program is saved.



Be careful when WRITE is enabled. You can change banks and tens without executing WRITE, but once you press a PROGRAM SELECTOR button (0-9) for the “ones” digit, the WRITE command is executed and the program at that location is overwritten.

To save a program to a different bank location:

1. Press the WRITE button. Its LED begins blinking.
2. Hold down the BANK button then press a PROGRAM SELECTOR button to specify the “hundreds” bank of the program. You can only save to Banks 0-4.
3. Hold down the TENS button then press a PROGRAM SELECTOR button (0-9) to specify the “tens” digit of the program.
4. Press a PROGRAM SELECTOR button (0-9) to specify the “ones” digit of the program.
5. The WRITE button LED stops blinking and the program is saved.

Canceling Save

Sometimes you may want to cancel saving a program before you commit.

To cancel the Save process before you commit:

- If the WRITE button LED is flashing, press it again. The LED stops flashing and saving is canceled. You can return to editing if you want.

Comparing Before You Save

Before saving a program to a new location, it's a good idea to listen to the program in the target location to make sure you really want to overwrite it.

To evaluate a program before you overwrite it:

1. Get ready to save by pressing the `WRITE` button. It starts flashing.
2. Press the `GLOBAL` button. Both LEDs on the button light up, indicating `COMPARE` mode.
3. Use the program buttons to navigate to the sound you want to compare and play the keyboard to hear the sound.
4. To disable the compare function and go back to the edited sound, turn off the `GLOBAL` button. Programs can't be written while in compare mode.
5. If you want to save the edited sound, the `WRITE` button is still flashing and ready to save, so enter a location with the program buttons. The sound is saved.
6. Alternatively, if you want to cancel saving and continue editing, press the `WRITE` button. It stops flashing and saving is canceled.

Moving to the Next Level

Before you start exploring the sound creation capabilities of the OB-6 we'd like to point you toward a few things that will help you tailor the instrument to your needs.

First, check out the *Global Settings* section of this manual. Read about Pot Modes and determine which works best for you when you're editing sounds. You'll also find information about MIDI setup. Read this to more effectively integrate the OB-6 into your MIDI rig. To get the most out of the OB-6's live performance capabilities, read up on using a footswitch or expression pedal.

And finally, be on the lookout for tips and notes scattered throughout this manual to gain a better working knowledge of the OB-6. The better you know it, the more you'll get out of it. We wish you many hours of musical exploration!

Connections

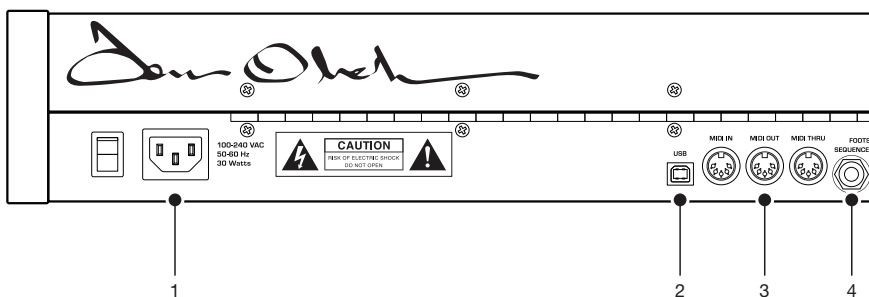

1. AC Power Connector—Accepts a standard, grounded IEC power cord. Operates over a range of 100 to 240 volts and 50 to 60 Hz.

2. USB—For bidirectional MIDI communication with a computer. The OB-6 is a Class Compliant USB device and does not require additional drivers when used with Mac OS or Windows. See *Using USB* on page 62 for more information.

3. MIDI In, Out, and Thru—Standard 5-pin MIDI DIN connectors.

4. Footswitch-Sequence—Accepts a momentary, normally open or normally closed footswitch to turn the sequencer or arpeggiator on and off. Alternatively, an audio signal connected to this jack can be used to either control sequencer/arpeggiator playback, or to gate the filter and loudness envelopes while notes are held. See “Seq Jack” on page 13 for more information about choosing the appropriate mode for these behaviors.



Audio signals used to drive the arpeggiator/sequencer should not exceed 5 volts peak-to-peak.

5. Footswitch-Sustain—Accepts a momentary, normally open or normally closed footswitch to control sustain. See Sustain” on page 14 for more information.

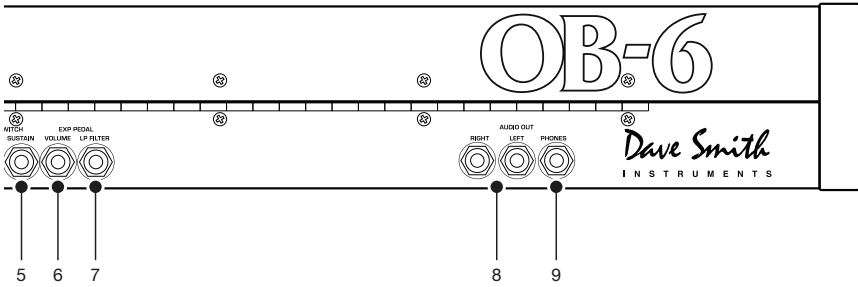

6. Expression Pedal-Volume—Accepts a standard expression pedal that has a variable resistor on a TRS (tip-ring-sleeve) ¼ inch phone plug. Once connected, you can use the pedal to control volume to add expressiveness and dynamics to live performance.

7. Expression Pedal- Filter—Accepts a standard expression pedal that has a variable resistor on a TRS (tip-ring-sleeve) ¼ inch phone plug. Once connected, you can use the pedal to control the cutoff frequency of the filter to add expressiveness to live performance.

8. Audio Outputs—Unbalanced, ¼ inch audio outputs. The OB-6 sounds great in stereo, but can be switched to mono if needed. See “Mono/Stereo” in *Global Settings* on page 14.

9. Headphones—A ¼ inch stereo headphone jack. Headphone volume is controlled by the MASTER VOLUME knob on the front panel.

Global Settings

Global settings are parameters that affect all programs. These include settings such as Master Tune, MIDI Channel, MIDI Clock, and others. Global parameters are printed above the numeric program selector switches (0 - 9). Use the Globals switch to choose between the two sets. The red LED indicates that the upper row is active. The yellow LED indicates that the lower row is active

GLOBALS



The Globals button

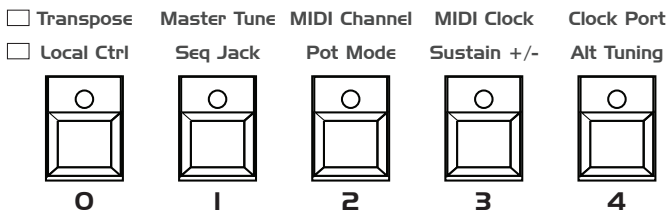

Globals 0-4

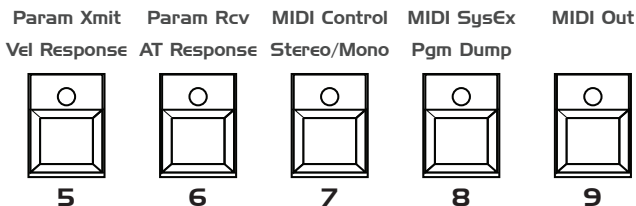

Globals 5-9



Use the Bank and Tens buttons to scroll forward and backward, respectively, through parameter settings

To set a Global parameter:

1. Press the **GLOBALS** button. Pressing it once activates the upper set of parameters. Pressing it a second time enables the lower set of parameters.
2. Press the program selector button (0 - 9) that corresponds to the desired parameter. The parameters are printed above each switch.
3. Use the **BANK** and **TENS** buttons as decrement and increment buttons to step through available settings.
4. Once you've chosen the desired setting, press the **GLOBALS** button again to exit.

Globals - Top Row

0. Transpose: -12...12—Master Transpose control, 0 is centered. Steps in semitones up to one octave up (+12) or down (-12).

1. Master Tune: -50...50—Master Fine Tune control; 0 centered. Steps in cents as much as a quarter-tone up (+50) or down (-50).

2. MIDI Channel: ALL, 1...16—Selects which MIDI channel to send and receive data, 1 to 16. ALL receives on all 16 channels.

3. MIDI Clock: Sets the OB-6's ability to send and receive MIDI clock messages:

- OFF: MIDI Clock is neither sent nor received
- ON: MIDI Clock is sent, but not received
- IN: MIDI Clock is received, but not sent
- Slave Thru (IN): MIDI Clock is received and passed to MIDI Out
- In, No Start/Stop (IN55): Receives MIDI Clock but does not respond to MIDI Start or Stop commands.



When set to IN or SLAVE THRU, if no MIDI clock is present at the selected input, the arpeggiator and sequencer will not function.

4. Clock Port: $\bar{i}i d, USB$ —Sets the ports, MIDI or USB, by which MIDI clock signals are received.

5. Param Xmit: OFF, CC, nr —Changes to the values of front panel controls are transmitted via MIDI as Continuous Controllers (CC) or Non-registered Parameter Number (nr). Transmission of parameters can also be turned off. You could, for example, turn the filter $FREQUENCY$ knob on the OB-6 and have it affect the cutoff frequency of another synthesizer. For a list of OB-6 CCs and NRPNs, see Appendix D.



NRPNs are the preferred method of parameter transmission, since they cover the complete range of all parameters, while CCs are limited to a range of 128.

6. Param Rcv: OFF, CC, nr —Sets the method by which parameter changes are received via MIDI. As with transmission, NRPNs are the preferred method.

7. MIDI Control: OFF, On —When On, the synth will respond to MIDI controllers, including Pitch Wheel, Mod Wheel, Pedal, Volume.

8. MIDI Sysex: $\bar{i}i d, USB$ —When set to MIDI ($\bar{i}i d$) it will receive and transmit them using the MIDI ports/cables. When set to USB it will receive and transmit them using the USB port/cable. MIDI SysEx messages are used when sending and receiving a variety of data including, programs, alternative tunings, system updates, and more.

9. MIDI Out: $\bar{i}i d, USB$ —Sets the port by which MIDI data will be transmitted (MIDI or USB).

Globals - Bottom Row

0. Local Control: OFF, On —When on (the default), the keyboard and front panel controls directly affect the OB-6. When off, the controls are transmitted via MIDI but do not directly affect the “local” synth (that is, the OB-6). This is primarily useful for avoiding MIDI data loops that can occur with some external sequencers.

1. Seq Jack: *NORM*, *TRIG*, *GATE*, *T-G* (Normal, Trigger, Gate, T-G)—Selects the mode for signals received on the rear-panel Sequencer jack.

- With *NORMAL* selected, a footswitch will start sequencer playback.
- With *TRIG* selected, an audio signal connected to the *SEQUENCER* jack will step the sequencer when the sequencer's *PLAY* button is on.
- With *GATE* selected, an audio signal connected to the *SEQUENCER* jack will trigger and gate the envelopes while you hold a note or chord. Additionally, turning on the sequencer or arpeggiator will add sequencer or arpeggiator playback—but controlled by the *OB-6*'s clock *BPM* and *VALUE* settings and not the audio trigger.
- With *T-G* (*TRIGGER+GATE*) selected, an audio signal connected to the *SEQUENCER* jack will trigger and gate the envelopes while you hold a note or chord. Additionally, pressing the sequencer's *PLAY* button will also add synchronized sequencer playback.



For best results when triggering the sequencer with an audio signal, use a loud signal with a sharp attack/decay and little or no sustain.

2. Pot Mode: *REL*, *PAS*, *JUP* (Relative, Passthru, Jump)—The rotary controls on the front panel are a mixture of “endless” rotary encoders and potentiometers or “pots.” The pots are identifiable by their lined knobs and the fact that they have about 300° of travel. There are three pot modes to determine how the synth reacts when the programmable parameters are edited. (Master volume is not programmable, so these modes don't apply.)

In *Relative* mode, changes are relative to the stored setting. In *Relative* mode, the full value range is not available until either the minimum or maximum value and the respective lower or upper limit of the pot's travel is reached. For example, the *RESONANCE* parameter has an internal value range of 0 to 127. Let's say the physical position of the *RESONANCE* pot is the equivalent to a value of 100. If you switch to a program that has a stored *Resonance* setting of 63 and turn the pot all the way up, it will only go to 90. To get to the maximum value of 127, you first have to turn down until the value is at the other extreme and the pot is at the limit of its travel (in this case, 0 and fully counter-clockwise, respectively).

In *Passthru* mode, turning the pot has no effect until after the edited value equals the preset value (that is, until the edited value “passes through” the stored value).

Jump mode uses an absolute value based upon the position of the pot when edited: turn a pot and the value jumps immediately from the stored value to the edited value.

3. Sustain +/- : *noo, rEu, o-r, r--o* (Normally Open, Normally Closed, Sustain Normally Open/Sequencer Normally Closed, Sustain Normally Closed/Sequencer Normally Open)—The Sustain pedal polarity parameter affects both the sustain pedal and sequencer jack input ports. There are two types of momentary footswitches, normally open and normally closed. Either type can be used with the OB-6. Not sure which type you have? If the behavior of the footswitch is the opposite of what is expected — that is, down is off and up is on — changing this setting will correct that.

4. Alt Tuning: *noo, 1... 16* (Normal, 1...16)—Selects one of the OB-6's built-in tunings. Set to *NORMAL*, the tuning is standard, chromatic tuning. Choosing 1 through 16 selects an alternative, non-chromatic, non-Western scale that can be used to emulate ethnic instruments or in other creative ways.

See “Appendix A: Alternative Tunings” on page 63 for a description of each tuning. Additional tunings can be imported into the OB-6 as a SysEx message. For more information, see Appendix A.

5. Vel Response: *0-3* (Curve 0, Curve 1, Curve 2, Curve 3)—Sets one of four velocity curves to adjust the keyboard's velocity response to your playing style.

6. AT Response: *0-3* (Curve 0, Curve 1, Curve 2, Curve 3)—Sets one of four pressure curves to adjust the keyboard's aftertouch response to your playing style.

7. Stereo/Mono: *StE, i-on* (Stereo, Mono)—The OB-6 defaults to stereo operation. When set to Mono, this parameter defeats all pan settings and modulation, effectively making each of the outputs a mono output.

8. Pgm Dump: *Prg, tEn, bAn, U5r, ALL* (Program, Tens, Bank, User Banks, All)—Transmits the current program, ten programs from the currently selected bank and tens location, the current bank, all user banks (0-4), or all banks (both user and factory) in SysEx format via the selected MIDI port. (See: “MIDI Sysex.”) Dumped programs will load back into the same bank and program location in memory when received by the OB-6 via MIDI.

Oscillators

Oscillators provide the raw building blocks of the OB-6’s sound by producing *waveforms*, each of which has its own inherent sound character based on its harmonic content. The OB-6 has two oscillators, plus a sub oscillator and a noise generator per voice. Level controls for each of these are located in the Mixer section.

Oscillator 1 is capable of generating sawtooth, and variable-width pulse waves. Oscillator 2 generates triangle, sawtooth, and variable-width pulse waves. These waveshapes are continuously variable and smoothly transition from one shape to the next as you turn the SHAPE knob. This provides a variety of “in-between” waveshapes.



The oscillators on the OB-6 are extremely stable. To emulate the random pitch drift and oscillator instability of vintage instruments, use the **DETUNE** parameter (next to the **UNISON** button) to dial in as little or as much drift as you like.

OSCILLATORS

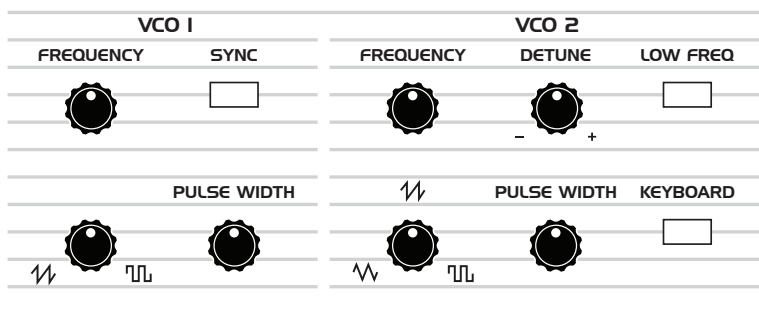

Oscillators 1 and 2

Oscillator 1 can be hard-synced to Oscillator 2 for complex, harmonically-rich sounds when modulated.

Oscillator 2 features a **DETUNE** knob for detuning and thickening sounds, a **LOW FREQ** switch that allows it to function as an LFO for modulation purposes, and a **KEYBOARD** switch that disables keyboard control over its pitch (useful when used as an LFO, or for drones and other effects).

Oscillator Parameters

Frequency: Sets the base oscillator frequency over a 9-octave range from 16 Hz to 8KHz (when used with the Transpose buttons). Adjustment is in semitones.



The global Master Tune settings affect the pitch of all oscillators. See “Globals - Top Row” on page 11 for more information.

Detune: Fine tune control with a range of a quartertone up or down. The 12 o’clock position is centered. Steps are in cents (50 cents = 1/2 semitone).

Shape: Sawtooth, Pulse (and Triangle on Osc 2) —Used to select the waveshape generated by the oscillator. Waveshapes are continuously variable and smoothly transition from one shape to the next as you turn the SHAPE knob. This provides a variety of “in-between” waveshapes.

Pulse Width: Changes the width of the pulse wave from a square wave when the PULSE WIDTH knob is at center position, to a very narrow pulse wave when the PULSE WIDTH knob is full left or right.



Applying pulse width modulation using X-MOD or the LOW FREQUENCY OSCILLATOR is a great way to add movement and thickness to a sound, especially when creating pad or string-like sounds.

Sync: Off, On—Turns Oscillator 1 hard sync on. Sync forces Oscillator 1 (the slave) to restart its cycle every time Oscillator 2 (the master) starts a cycle. This provides a way to create more complex, harmonically rich shapes from simple waveforms—especially when the frequency of Oscillator 1 is set to a different interval than Oscillator 2.

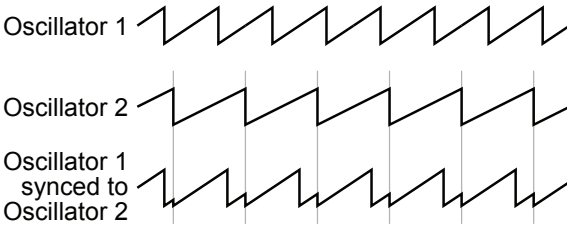

Oscillator hard sync



Use X-Mod to sweep the pitch of Oscillator 1 when it is synced to generate the classic, hard-edged sync sound.

Low Frequency: Off, On—Turns Oscillator 2 into a low-frequency oscillator, essentially providing another LFO source for modulation using X-Mod. The **FREQUENCY**, **DETUNE**, **SHAPE**, and **PULSE WIDTH** controls still apply and will affect the character of any low-frequency modulation applied using Oscillator 2.

Keyboard: Off, On—When off, the Oscillator 2 ignores the keyboard and note data received via MIDI and plays at its base frequency setting. Oscillator 2 pitch can still be affected by modulation from other sources when in this mode.

Detune

Detune (next to the UNISON button) adds randomized detuning to the oscillators to emulate the tuning instability of vintage analog oscillators. This tuning instability is a big part of what made vintage instruments sound characteristically warm and fat.

Because the OB-6 oscillators are extremely stable, small amounts of DETUNE can help impart a very vintage tone to what is otherwise a very stable, modern instrument. DETUNE amount is adjustable from subtle to wildly out of tune.

When UNISON is enabled, DETUNE detunes the unison voices by a fixed amount. Using the PAN SPREAD feature, if an odd number of voices is stacked, one of the voices is placed in the center of the stereo field with the other voices spread right and left. The higher the pan spread setting, the wider the stereo spread in unison.

DETUNE



UNISON

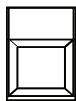

The DETUNE knob



The global Master Tune settings affect the pitch of all oscillators. See “Globals - Top Row” on page 11 for more information.

Mixer

The Mixer section is where you set the levels of the various sound generators on the OB-6. These include VCO 1, VCO 2, Sub Octave (Oscillator 1 sub oscillator) and the white noise generator. You must turn up at least one of these in order to make sound with the OB-6.



Rather than limit the OB-6's outputs to keep the instrument from clipping, we allow you to adjust levels at various points in its signal path. This gives you the option to “overload” things in interesting ways, if you wish to do so. If not, try reducing the levels of the oscillators in the MIXER section, the ENV AMOUNT parameter in the Loudness Envelope, or the RESONANCE parameter in the filter.

MIXER

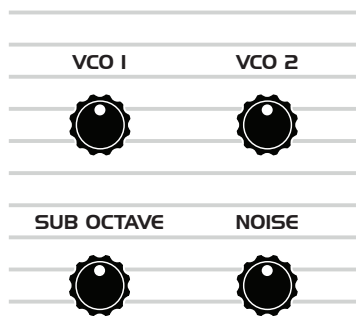

The Mixer

VCO 1: Sets the output level of Oscillator 1.

VCO 2: Sets the output level of Oscillator 2.

Sub Octave: Controls the level of a square wave oscillator pitched one octave below Oscillator 1. Adding a sub octave to sounds such as bass are a great way to increase their low-register presence.

Noise: Sets the output level of the white noise generator.

Filter

The Filter takes the basic, raw sound of the oscillators and noise generator and subtracts frequencies, changing the harmonic content and character of their sound. This change can be varied over time using the Filter Envelope to produce more dynamic, animated timbres.

The OB-6's filter is a 2-pole, 12 dB per octave, analog, state-variable filter with low-pass, notch, high-pass, and band-pass modes.

The filter mode knob sets the filter's mode of operation. It transitions smoothly from low-pass to notch to high-pass operation, allowing a blending of these modes. Band-pass operation is selected with the BP switch. Each filter mode has its own characteristic sound and function:

- Low-pass: passes frequencies below the cutoff frequency
- Notch: removes frequencies in a notch centered around the cutoff frequency
- High-pass: passes frequencies above the cutoff frequency
- Bandpass: passes a band of frequencies centered around the cutoff frequency



Band-pass mode is selectable only through the BP on/off switch. However, you can actually smoothly transition between normal and band-pass operation by choosing NORM-BP as a X-Mod destination in the mod matrix.

FILTER

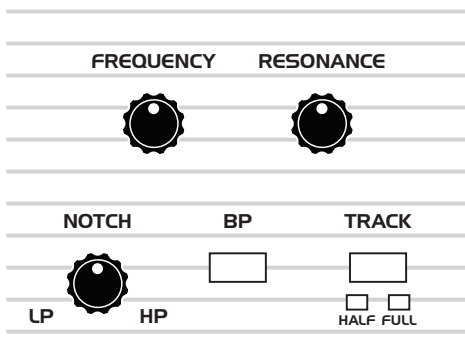

The OB-6 Filter

Frequency: Sets the filter’s cutoff frequency. In Low-Pass mode, frequencies are reduced from the top down — cutting the high frequencies and passing the low, hence the name “low-pass.” In High-Pass mode, frequencies are reduced from the bottom up — cutting the low frequencies and passing the high, hence the name “high-pass.” In Notch mode, frequencies are removed in a notch centered around the cutoff frequency. In Bandpass mode, a band of frequencies are passed through the filter centered around the cutoff frequency — while frequencies on either side of that band are removed.

Resonance: Emphasizes a narrow band of frequencies around the cutoff frequency. Unlike low-pass filters on some synthesizers, the OB-6 Low-Pass filter does not self oscillate. This is faithful to the original Oberheim SEM design.



High levels of resonance can sometimes cause the OB-6 outputs to clip if its sound generators are also set to high output in the Mixer. Monitor your outputs carefully to ensure optimal, clean signal levels. If you experience signal clipping, try reducing the levels of the oscillators in the MIXER section, the AMOUNT parameter in the Loudness Envelope, or the RESONANCE parameter in the filter.

Track: off, half, full—Sets the amount of modulation from the keyboard to the filter’s cutoff frequency. Selecting HALF or FULL means that the higher the note played on the keyboard, the more the filter opens. This is useful for adding brightness to a sound as higher notes are played, which is typically how acoustic instruments behave. If both HALF and FULL are off, keyboard filter tracking is off, meaning that filter frequency is unaffected by playing higher or lower notes on the keyboard.

Filter Envelope

The OB-6 filter has a dedicated, four-stage envelope generator. The Filter Envelope is used to shape the harmonic characteristics of a synthesized sound by giving you filtering control over its attack, decay, sustain, and release stages.

This is one of the most important factors in designing a sound. Without an envelope, the filters would be completely static. They would stay open or closed by a fixed amount that wouldn't change over the duration of a sound. That's not very interesting to listen to and it's not how instruments behave in the real world.

In general, sounds produced by an instrument are brighter at their beginning (the attack stage) and grow mellower as they die out (the decay and release stages). In other words, their harmonic content changes over time. This is exactly what the filter envelope is designed to emulate.

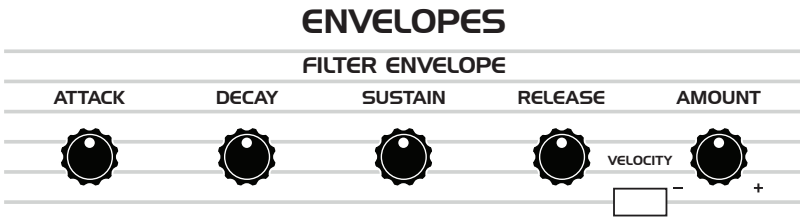

Filter Envelope

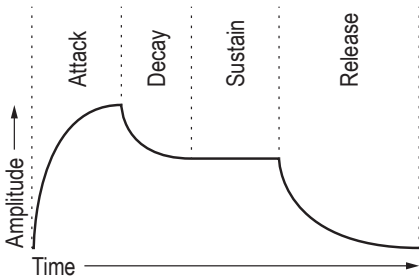

A typical 4-stage envelope

Attack: Sets the attack time of the envelope. The higher the setting, the slower the attack time and the longer it takes for the filter to open from the level set with the filter `FREQUENCY` knob to the level set by the filter envelope amount. Percussive sounds typically have sharp (short) attacks.

Decay: Sets the decay time of the envelope. After a sound reaches the filter frequency set at its attack stage, `DECAY` controls how quickly the filter then transitions to the cutoff frequency set with the `SUSTAIN` knob. The higher the setting, the longer the decay. Percussive sounds, such as synth bass, typically have shorter decays (and a generous amount of low-pass filter resonance).

Sustain: Sets the filter cutoff frequency for the sustained portion of the sound. The sound will stay at this filter frequency for as long as a note is held on the keyboard.

Release: Sets the release time of the envelope. This controls how quickly the filter closes after a note is released.

Velocity: on, off—When enabled, allows key velocity to influence filter frequency. If the `AMOUNT` is set to a positive value in low-pass filter mode, the harder you play, the more the filter will open and the brighter the sound will be. Conversely, if the `AMOUNT` is set to a negative value, the harder you play, the more the filter will close and the less bright the sound will be. This control makes for more touch-sensitive sounds

Amount: Sets the amount of modulation from the filter envelope to the filter. Higher amounts more dramatically affect the cutoff frequency. This control is bipolar. Positive settings produce standard behavior. Negative settings invert the envelope.



The description of envelope behavior above is true when the `AMOUNT` parameter is set to a positive value. But since this control is actually bi-polar, it is possible to set a negative amount of modulation. In this case, the envelopes are inverted and their behavior changes. The best way to get a feel for the difference is to experiment with both positive and negative settings of the `ENVELOPE AMOUNT` parameter.



The cutoff frequency setting may limit the effect of the envelope on the filter. For example, in low-pass filter mode, if `FREQUENCY` is at its highest setting, a positive envelope amount will have no effect on the filter since the filter is already completely open.

Changing the Filter Envelope's Response Curve

By default, the envelopes of all synthesizers are designed to have certain type of response curve that is largely dependent on the preference of the designer. In most cases, this can't be changed. The current preference is that the faster or snappier the envelopes, the better.

However, in the case of the OB-6, there is a hidden feature in the X-Mod section that allows you to modify the responsiveness of the Filter Envelope's ADSR controls. This opens up a new level of fine adjustment of these controls that is subtle but powerful. Try it and see.

To adjust the responsiveness of the filter envelope:

1. Select a program — such as a synth brass sound — that has a slightly soft but bright attack.
2. Repeatedly play a series of notes or chords on the keyboard, so you can hear the effect of the adjustments as you follow the steps below.
3. In the X-Mod section, enable the `FILTR FREQ` as the only destination (disable all other X-Mod destinations such as `VCO 1`, `SHAPE 1`, etc.).
4. In the X-Mod section, turn the `FILTER ENV` control slightly counterclockwise. Try a setting of about 11 o'clock.
5. Continue to play a series of chords and turn the `AMOUNT` knob in the `FILTER ENVELOPE` section. Try moving it back and forth between 1 o'clock and 3 o'clock.
6. As you do this, compare different settings of the X-Mod `FILTER ENV` control, the Filter Envelope `AMOUNT`, and different Attack, Decay, Sustain, and Release settings on the Filter Envelope.

The interaction of these controls is worth exploring for greater flexibility and control of the Filter Envelope.

Loudness Envelope

After passing through the filters, a synthesized sound goes into an analog voltage controlled amplifier or VCA, which controls its overall loudness. The VCA has a dedicated, four-stage envelope generator.

The Loudness Envelope is used to shape the volume characteristics of a sound over time by giving you control over its attack, decay, sustain, and release stages. Along with the filter envelope, this is one of the most important factors in designing a sound.

Without a loudness envelope, the volume of a sound wouldn't change over the duration of a note. It would begin immediately, remain at its full volume for the duration of the note, then end immediately when the note was released. Again, that's not very interesting sonically and it's not typically how instruments behave in the real world.

To give you a real-world example, the main difference between the sound of the wind and the sound of a snare drum is that they have very different loudness envelopes. Otherwise, they are essentially both white noise. Wind has a relatively slow attack, a long sustain, and a long decay and release. A snare drum has a sharp attack, no sustain, and virtually no decay or release. But again, they are both fundamentally white noise.



Loudness Envelope

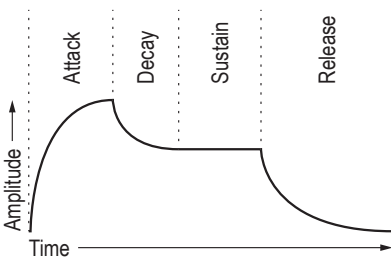

A typical four-stage, ADSR envelope shape

Attack: Sets the attack time of the envelope. The higher the setting, the slower the attack time and the longer it takes for a sound to reach its full volume. Pads typically have softer (longer) attacks. Percussive sounds have sharper (shorter) attacks.

Decay: Sets the decay time of the envelope. After a sound reaches its full volume at its attack stage, **DECAY** controls how quickly the sound transitions to the level set with the **SUSTAIN** control. The higher the setting, the longer the decay. Percussive sounds, such as synth bass, typically have shorter decays.

Sustain: Sets the sustain level of the envelope. The higher the setting, the louder the sustained portion of the sound will be. The sound will stay at this level for as long as a note is held on the keyboard.

Release: Sets the release time of the envelope. This controls how quickly a sound dies out after a note is released.

Amount: Sets the amount of modulation from the Loudness Envelope to the VCA. In most cases you will probably want to set this fully clockwise for maximum VCA volume. If you experience signal clipping, try reducing the **ENV AMOUNT** or the levels of the oscillators in the **MIXER** section.



To recreate the “gated VCA” effect used on certain classic rock anthems, choose an organ sound, then set the **LOUDNESS ENVELOPE** amount to zero, route the LFO square wave to **AMP** with an **INITIAL AMT** setting of 100% and hold a few chords.

Velocity: This button enables keyboard velocity to modulate the Loudness Envelope amount. The harder you play, the more the Loudness Envelope is affected. This makes for more touch-sensitive sounds.

Effects

The OB-6 EFFECTS section allows you to add up to two, 24-bit, 48 kHz digital effects to any sound. Though the OB-6 sounds great on its own, adding a touch of reverb or delay can enhance many sounds with a subtle (or not so subtle) sense of ambience and depth. Other effects such as the chorus and phaser are useful for adding more conspicuous tonal enhancement as well as emulating classic instruments such as string ensembles and so on.

While the effects themselves are digital, the main signal path of the OB-6 is analog. The ON/OFF switch enables and disables both Effect A and Effect B, using a true bypass, ensuring a pure analog signal path.

Effects settings are saved individually with each program. Time-based effects such as the Delays can be synchronized to the arpeggiator, sequencer, or MIDI clock to produce repeats that occur on the beat.

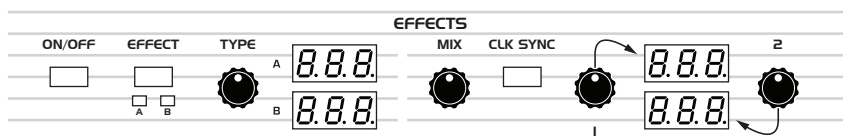

The Effects section

Effects are divided into sets A and B. You can choose a single effect from each set. Effect A and B are applied one after another, in series. For this reason, reverb effects are only available as Effect B, since it's the last stage in the serial effects chain — where reverb is traditionally applied. Either effect can also be set to “off.”

Effect A:

- Delay 1 (“*bbd*”) - vintage bucket-brigade emulation
- Delay 2 (“*ddl*”) - classic digital delay
- Chorus (“*[HD]*”) - vintage chorus
- Flanger 1 (“*FL 1*”) vintage flanger, high resonance
- Flanger 2 (“*FL 2*”) vintage flanger, no feedback
- Phase Shifter 1 (“*PH 1*”) vintage 6-stage phaser, high resonance
- Phase Shifter 2 (“*PH 2*”) vintage 6-stage phaser, lower resonance
- Phase Shifter 3 (“*PH 3*”) faithful emulation of Tom Oberheim’s original 6-stage phaser
- Ring Modulator (“*r in*”) faithful emulation of Tom Oberheim’s original ring modulator design

Effect B:

- Delay 1 (“*bbd*”) - vintage bucket-brigade emulation
- Delay 2 (“*ddl*”) - classic standard digital delay
- Chorus (“*[HD]*”) - vintage chorus
- Flanger 1 (“*FL 1*”) vintage “through-zero” flanger, high resonance
- Flanger 2 (“*FL 2*”) vintage “through-zero” flanger, no feedback
- Phase Shifter 1 (“*PH 1*”) vintage 6-stage phaser, high resonance
- Phase Shifter 2 (“*PH 2*”) vintage 6-stage phaser, lower resonance
- Phase Shifter 3 (“*PH 3*”) faithful emulation of Tom Oberheim’s original 6-stage phaser
- Ring Modulator (“*r in*”) faithful emulation of Tom Oberheim’s original ring modulator design
- Reverb 1 (“*HRL*”) - classic hall emulation
- Reverb 2 (“*r □□*”) - classic room emulation
- Reverb 3 (“*PLR*”) - classic plate emulation
- Reverb 4 (“*SPR*”) - vintage guitar-amp-style spring emulation

To use Effects:

1. Press the ON/OFF switch to turn on Effects.
2. Press EFFECT and choose A or B, depending on which you want to apply and configure.
3. Turn the TYPE knob to select an effect. Names are abbreviated. For instance “bbd” is the bucket-brigade delay. Refer to the list above.
4. Turn the MIX knob to the right to blend in a good amount of the processed signal. You’ll want to be able to clearly hear the effect when you tweak its settings. You can dial it down afterward.
5. Use the parameter 1 and parameter 2 knobs to adjust the effect’s parameters to your taste. See “Effects Parameters” on page 29 for details on the adjustable parameters on each effect type.
6. Finally, adjust the MIX knob to optimize the amount of the effect. Full left is completely dry. Full right is completely wet (a 100% processed signal).
7. Repeat as needed to add a second effect.

Effects Parameters

On/Off: Turns both effects, A and B, on and off. The ON/OFF switch uses a true bypass, ensuring a pure analog signal path.

Effect: A, B—Selects either effect A or B for editing. Once selected, all adjustments apply to that effect.

Type: OFF, bbd, ddL, CHD, FL 1, PH 1, PH2, PH3, rrs, HAL, rDD, PLR, SPr—Selects the effect type.

Mix: 0... 127—Sets the balance between the processed (wet) signal and unprocessed (dry) signal. Full left is completely dry. Full right is completely wet.

Clock Sync: ON, OFF—When a delay effect is chosen, this enables syncing of the timed delay repeats (feedback) to the Arpeggiator, Sequencer, or MIDI clock. When Sync is on, delay time provides the following values:

Value	Delay Time
1	4 beats
2d	3 beats
2	2 beats
4t	1 beat
4d	1 1/2 beat
4	1 beat
8d	3/4 of 1 beat
8	1/2 of 1 beat
8t	1/2 of 1 beat
16d	3/8 of 1 beat
16	1/4 of 1 beat



Maximum delay time is 1 second. The combination of longer synced delay times with slower tempos can result in delay times that would be greater than 1 second. When that happens, the delay time is divided by 2 until it no longer exceeds the 1 second limit. For example, if the BPM is set to 60 and Delay Time is set to Half, the expected delay time would be 2 seconds. The actual delay time will be 1 second (i.e. 2 seconds divided by 2).

Parameter 1: Variable, depending on the effect—This knob adjusts parameter 1 for the chosen effect. Each effect has two adjustable parameters, which differ depending on the effect.

Parameter 2: Variable, depending on the effect—This knob adjusts parameter 2 for the chosen effect. Each effect has two adjustable parameters, which differ depending on the effect.

Display	Effect Type	Parameter 1	Parameter 2
<i>bbd</i>	bucket-brigade delay	delay time	feedback amount
<i>ddl</i>	digital delay	delay time	feedback amount
<i>cho</i>	chorus	rate	depth
<i>FL1</i>	flanger	rate	depth
<i>FL2</i>	flanger	rate	depth
<i>PH1</i>	phaser 1	rate	depth
<i>PH2</i>	phaser 2	rate	depth
<i>PH3</i>	phaser 3	rate	depth
<i>rim</i>	ring modulator	modulator frequency	low-note pitch tracking on/off
<i>HRL</i>	hall reverb	time	early reflections
<i>ROO</i>	room reverb	time	early reflections
<i>PLA</i>	plate reverb	time	early reflections
<i>SPR</i>	spring reverb	decay	tone

bbd: This is a vintage bucket-brigade delay emulation. Bucket-brigade delays were originally a type of analog delay characterized by relatively short delay times and a warmer character than digital delays due to their loss of treble and clarity in the delayed analog signal. Adjustable parameters are delay time and feedback amount.



To recreate a classic bucket-brigade time-shifting effect, try adjusting the `TIME` parameter in real time.

ddl: This is a classic digital delay. Adjustable parameters are delay time and feedback amount.

CHO: This is a vintage chorus emulation. Use it to thicken and add animation to any sound. Adjustable parameters are rate and depth.

FL1: This is a vintage flanger emulation. Use it to add a sweeping resonant effect to a sound. This effect has true through zero flanging capability. Adjustable parameters are rate and depth.

FL2: This is a vintage flanger without a feedback path and is designed to emulate the through zero capability of tape deck flanging. Use it to add a sweeping flanged effect to a sound. Adjustable parameters are rate and depth.

PH1: This is a vintage phaser emulation with high resonance. Use it to add a deep, sweeping, swirling resonant effect to a sound. Adjustable parameters are rate and depth.

PH2: This is a vintage phaser emulation with lower resonance. Use it to add a swirling resonant effect to a sound. Adjustable parameters are rate and depth.

PH3: This is a faithful emulation of Tom Oberheim's original phaser design. Use it to add a swirling resonant effect to a sound. Adjustable parameters are rate and depth.

rin: This is a faithful emulation of Tom Oberheim's original ring modulator design. Use it to add a complex harmonic effect to a sound. Adjustable parameters are the modulation frequency and low note pitch tracking on/off.



The ring modulator's mode of operation is determined by the setting of Parameter 2, (pitch tracking) which can be set to either on or off. With this parameter off, the ring modulator functions like the original Oberheim unit. In this mode, pitch tracking is off, and Parameter 1 sets the modulation frequency, which remains the same regardless of what note you play on the keyboard. With parameter 2 on, the ring modulator tracks the pitch of the lowest note that you play on the keyboard. In this case the Parameter 1 sets a ratio between the lowest note that you play and the modulator note (instead of setting a fixed frequency). The modulation frequency will then change as you change the lowest note that you're playing, so that the ratio will remain constant between the note that you play and note of the modulator. If you are only playing one note at a time, then the ring modulator will modulate with the same ratio as you play up and down the keyboard.



Set Parameter 2 to the "on" position to get more musical results from the ring modulator.

HAL: This is a Hall reverb. It's the largest of the available reverbs. Adjustable parameters are reverb time and early reflection amount.

rOO: This is a Room reverb. It's the second largest of the available reverbs. Adjustable parameters are reverb time and early reflection amount.

PLA: This is a Plate reverb. It emulates a classic reverb plate. Adjustable parameters are reverb time and early reflection amount.

SPr: This is a Spring reverb. It emulates a vintage, guitar-amp-style reverb. Adjustable parameters are decay and tone.

Distortion

The OB-6 provides an analog distortion effect. This can be used to add warmth, harmonic complexity, and an aggressive edge to sounds. The character of the distortion is affected by the harmonic content of a program. Sounds with more high-end will sound different than sounds with fewer harmonics.

To add distortion:

1. Press and hold the EFFECT button.
2. Turn the MIX knob to set the distortion amount.
3. Release the EFFECT button.

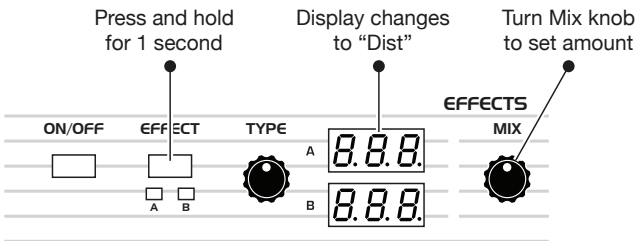

Adding the Distortion effect

Low Frequency Oscillator

The LFO is a special-purpose oscillator that produces a frequency below the range of human hearing. The LFO is typically used for periodic modulation such as vibrato (periodic pitch modulation) and tremolo (periodic amplitude modulation).

The LFO on the OB-6 produces a variety of waveshapes, including sine, sawtooth, reverse sawtooth, square, and random. Though most often used for low-frequency modulation, the OB-6 LFO can actually function at speeds that extend into the audible range for extreme effects.

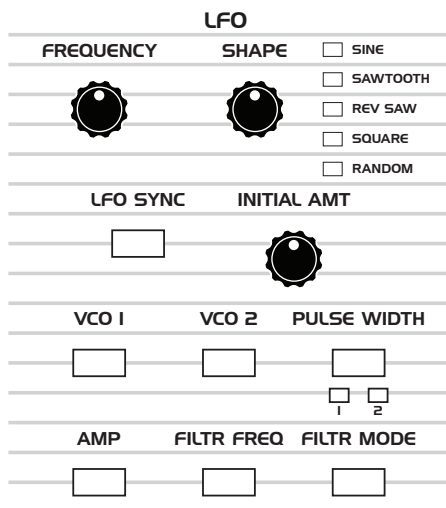

The Low-Frequency Oscillator

Sine and Random waves are bipolar. That is, their waveshape is positive for half of their cycle and negative for the other half. In the case of the sine wave, this makes it possible to generate a natural-sounding vibrato that goes alternately sharp and flat in equal amounts on either side of a center frequency. Random, also known as “sample and hold,” generates a series of random values, each held for the duration of one cycle

The square wave, sawtooth, and reverse sawtooth generate only positive values. In the case of the square wave this makes it possible to generate natural-sounding trills.

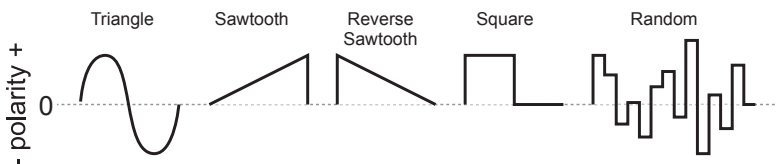

LFO waveshapes



The OB-6 has a sixth “hidden” LFO waveshape that you can use as a modulation source — noise. To access this, choose **RANDOM** then turn **FREQUENCY** all the way clockwise. This generates a white noise waveform.

The LFO can be free-running or synced to the arpeggiator, sequencer, or MIDI clock for tempo-synced effects such as filter sweeps, tremolo, and so on.

Frequency: Sets the frequency of the LFO waveshape routed to the destination from a slow .022Hz to a fast 500Hz. See also “LFO Sync” below.

LFO Sync: When on, the LFO synchronizes with the arpeggiator, sequencer, or MIDI clock. By default, the LFO wave cycle is reset when you press a key (but is not reset if you press a key while other notes are held).

Shape: Sine, Sawtooth, Reverse Sawtooth, Square, Random—The wave shape of the LFO. A sixth waveshape, noise, can be generated by selecting **RANDOM** and turning the **FREQUENCY** knob all the way to the right.

Initial Amount: Sets the amount of LFO modulation routed to the selected destinations. Setting an amount here applies the selected modulation continuously. If you set this parameter to zero but still select a modulation destination, modulation is only applied when you use the Mod Wheel.

VCO 1: Selects the frequency of Oscillator 1 as a modulation destination. Use a sine wave as a source to create vibrato. Use a square wave to create trills.

VCO 2: Selects the frequency of Oscillator 2 as a modulation destination. Use a sine wave as a source to create vibrato. Use a square wave to create trills.

Pulse Width: (Individually selectable for Oscillator 1 and Oscillator 2)
When Oscillator 1 or 2 are set to square wave, this modulates the pulse width of the wave. Use a sine wave LFO to create a chorus-like effect often used to emulate strings.

Amp: Selects the amplitude level as a modulation destination. Use a sine wave LFO to create a tremolo effect.

Filtr Freq: Selects the filter cutoff frequency as a modulation destination. Use a sine wave LFO to create an auto-wah effect when in low-pass filter mode. Modulating the filter at high frequencies can create interesting timbres.

Filtr Mode: Selects the filter mode as a modulation destination, changing smoothly between low-pass, notch, and high-pass modes. Modulating the filter at high frequencies can create interesting timbres.

X-Mod

Although the overall sonic character of the OB-6 is determined by its analog oscillators and filters, much of its power to make truly unique and unusual sounds comes from the X-Mod section.

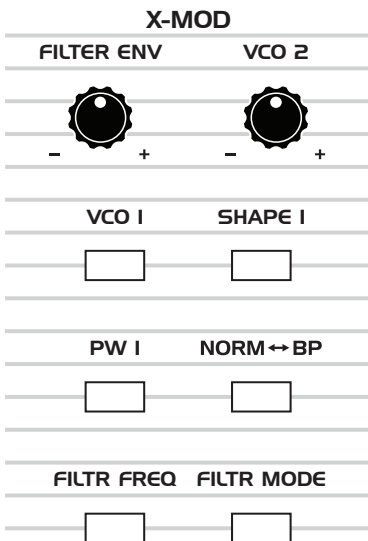

The X-Mod section

X-Mod modulation sources:

- Filter envelope
- VCO 2 frequency

X-Mod modulation destinations:

- VCO 1 frequency
- VCO 1 waveshape
- VCO 1 pulse width
- Filter cutoff frequency
- Normal to Bandpass filter mode
- Filter mode (Low-Pass, Notch, High-Pass)

You can control how much the source affects the destination by dialing in a specific modulation amount with the `FILTER ENV` or `VCO 2` knobs. Modulation amount can either be positive or negative.

Use X-Mod to create complex harmonic effects ranging from FM (frequency modulation) to audio-rate filter modulation and beyond. Many classic sounds on the original Oberheim OB-series of synthesizers were created through clever use of X-Mod.

X-Mod Parameters

Filter Env: Selects the amount of modulation from the Filter Envelope that is applied to a selected destination. Modulation amount can be either positive or negative.

VCO 2: Selects the amount of modulation from Oscillator 2 that is applied to a selected destination. Modulation amount can be either positive or negative.



When using VCO 2 as a modulation source, the modulation character is affected by the waveshape currently chosen for Oscillator 2 (triangle, sawtooth, or square/pulse). Try setting Oscillator 2 to low frequency (using the `LOW FREQ` switch) to further increase modulation possibilities.

VCO 1: Selects Oscillator 1 frequency as a modulation destination. Choose VCO 2 as a modulation source to produce FM effects with their characteristic complex harmonics and metallic timbre.

Shape 1: Selects the Oscillator 1 waveshape as a modulation destination. This can animate the timbre of Oscillator 1 in interesting ways.

PW 1: When Oscillator 1 is set to pulse wave, choosing this as a destination modulates its pulse width. This will animate the timbre of Oscillator 1 in interesting ways.

Norm - BP: Selects the filter mode as a modulation destination, changing smoothly between normal filter behavior (low-pass, notch, and high-pass modes) and bandpass mode.

Filtr Freq: Selects the filter cutoff frequency as a modulation destination. Use a sine wave LFO to create an auto-wah effect when in low-pass filter mode. Modulating the filter at high frequencies can create interesting timbres.

Filtr Mode: Selects the filter mode as a modulation destination, changing smoothly between low-pass, notch, and high-pass modes. Modulating the filter at high frequencies can create interesting timbres.

Arpeggiator

The OB-6 has a full-featured Arpeggiator. Turn it on, hold a chord and the OB-6 will play a pattern based on the individual notes held. Choose a mode (up, down, random, etc.), an octave range (1, 2, or 3), and a tempo, then pair it with an appropriately percussive sound, and you'll be surprised at the number of creative things you can do.

When HOLD is active, the Arpeggiator is in “relatch” mode, where playing a new chord latches to the new chord rather than adding notes to the existing chord.

If you enable HOLD, you can release the notes on the keyboard and the Arpeggiator will continue to play. In addition, the Arpeggiator features auto-latching: With HOLD on, played notes are held on and arpeggiated, and any additional notes you play are added to the arpeggio—as long as at least one key is continuously held.

You can sync the Arpeggiator to external MIDI clock, or even an external audio signal. When the Arpeggiator is playing, the Sequencer is disabled.

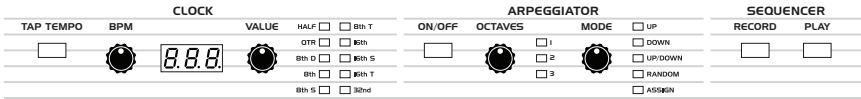

The Arpeggiator section

To use the Arpeggiator:

1. Press the Arpeggiator ON/OFF switch to turn it on.
2. Hold down one or more notes on the keyboard. The Arpeggiator plays them according to the settings you’ve chosen.
3. To latch arpeggiation on (so that you don’t have to continuously hold down notes) press the HOLD button.
4. Adjust settings such as MODE, OCTAVE, REPEATS, BPM and VALUE.
5. To synchronize a delay effect to the Arpeggiator, turn on CLOCK SYNC in the Effects section, choose a delay, and adjust its delay time setting as desired.



An audio signal connected to the rear-panel FOOTSWITCH - SEQUENCE jack can be used to control arpeggiator (and sequencer) playback. This makes it possible to tempo sync the arpeggiator to a recorded drum track or other audio source. Audio signals used to drive the arpeggiator/sequencer should not exceed 5 volts peak-to-peak. See “Seq Jack” on page 13 for more information about choosing the appropriate mode for these behaviors.

Arpeggiator Parameters

Tap Tempo—Tapping the **TAP TEMPO** button sets the tempo from 30 to 250 BPM. The LED flashes at the BPM rate you set. Tap the button at least 4 times to set the tempo.

BPM: 30...250—Sets the tempo for the arpeggiator in BPM (beats per minute). The **TAP TEMPO** LED flashes at the BPM rate. When **LFO SYNC** is enabled on the low-frequency oscillator, or **CLOCK SYNC** is enabled in the Effects section, the BPM rate affects the LFO frequency and/or delay effect. When syncing to an external MIDI clock source, the BPM setting has no effect.

Value—Selects a basic note value relative to the BPM. See the table below:

Name	Tempo	Timing Division
Half	BPM/2	Half note
Qtr	BPM	Quarter note
8th	BPM x 2	Eighth note
8th D	BPM x 2	Eighth note, dot
8th S	BPM x 2	Eighth note, swing timing
8th T	BPM x 3	Eighth note triplets
16th	BPM x 4	Sixteenth note
16th S	BPM x 4	Sixteenth note, full swing timing
16th T	BPM x 6	Sixteenth note triplets
32nd	BPM x 8	Thirty-second note

On/Off—Turns the Arpeggiator on and off.

Octave: 1 Octave, 2 Octaves, 3 Octaves—Set to 1 Octave, only the keyed notes are arpeggiated. Set to 2 Octaves, the keyed notes and the notes one octave above them arpeggiate. Set to 3 Octaves, the keyed notes and the notes one and two octaves above them arpeggiate.

Mode: Sets the order in which notes play when Arpeggiator is on. See the table.

Arp Mode	Behavior
Up	Plays from lowest to highest note
Down	Plays from highest to lowest note
Up + Down	Plays from lowest to highest and back to lowest
Random	Plays notes in random order
Assign	Plays notes in the order the keys were pressed

Sequencer

The OB-6's sequencer is similar to a classic step sequencer. It allows you to create a single sequence of up to 64 steps, including rests and ties, with up to 6 notes per step. In addition, you can play along with a sequence (provided there is available polyphony), making it a powerful live performance tool. When the Sequencer is playing, the Arpeggiator is disabled.

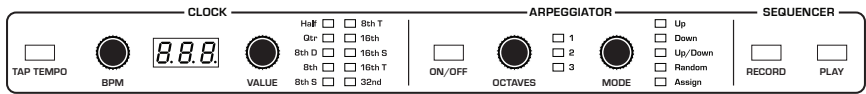

The Sequencer/Arpeggiator



An audio signal connected to the rear-panel FOOTSWITCH - SEQUENCE jack can be used to control sequencer playback. This makes it possible to tempo sync the sequencer (or arpeggiator) to a recorded drum track or other audio source. Audio signals used to drive the arpeggiator/sequencer should not exceed 5 volts peak-to-peak. See “Seq Jack” on page 13 for more information about choosing the appropriate mode for these behaviors.

Programming the Sequencer

Though programming the sequencer is simple, you can create sequences that are rhythmically and melodically complex by combining a repeating phrase or bass line with chords, ties, and rests. You can play up to 64 steps with up to 6 notes held simultaneously per step. For most sequences you'll probably want to use sounds with a relatively sharp attack and short release.



Most factory programs have a sequence associated with them. Recall a program and press the Sequencer's **PLAY** button to hear its associated sequence.

To program a note sequence:

1. Press the **RECORD** button.
2. Perform the sequence on the keyboard. The display indicates the current step as you play.



When recording a chord as a step, as long as you continue to hold at least one note down, you can keep adding notes to the chord/step, and even use the **TRANPOSE** buttons to extend the keyboard range while doing it.

3. To add a rest as you play, press the **TENS/INCREMENT** button for that step, then continue playing.
4. To add a “tie” that extends the length of a note, continue to hold down the note(s) and press the **TENS/INCREMENT** button repeatedly to extend the note the number of steps you want.
5. To step back a step in the sequence, press the **BANK SELECT/DECREMENT** button. This will step back to the previous step so that you can rerecord it. (Stepping back erases the step.)
6. When you're done, press **PLAY** to listen to your sequence.
7. To save the sequence, save the program and they are saved together. (See “Saving a Program” on page 5.)



If you want to play live along with the sequencer, be sure to leave voices available. In other words, don't play 6-note chords for every step in the sequence!

To play a sequence:

1. Press **PLAY**. The sequence plays back at the current BPM setting.
2. To stop playback, press **PLAY** again.



Alternatively, you can start and stop sequencer playback using a footswitch connected to the rear-panel **SEQ** jack or using MIDI start/stop messages sent from a DAW or other MIDI device. See “Seq Jack” on page 13 for more information.



Use the BPM, VALUE, or TAP TEMPO controls to adjust sequencer playback speed.

To transpose a sequence:

1. Press PLAY. The sequence begins playback.
2. Press and hold RECORD and press a key on the keyboard. “Middle C” is the reference point. Playing a note above middle C transposes the sequence higher by that interval. Playing a note below middle C transposes the sequence lower by that interval.

Sequencer Parameters

Here are the controls and parameters used when interacting with the sequencer.

Record: On, Off—This switch turns sequencer recording on and off.

Play: On, Off—This switch turns sequencer playback on and off.

BPM: 30...250—Sets the tempo for the Sequencer and Arpeggiator in BPM (beats per minute). The TAP TEMPO LED flashes at the BPM rate. When LFO SYNC is turned on, the BPM rate affects the LFO frequency. When syncing to an external MIDI clock source, the BPM setting has no effect.

Tap Tempo: 30...250—Tap this button at least 4 times to quickly set the tempo for the Sequencer and Arpeggiator. The LED flashes at the BPM rate you set.

Value: Sets the note value for each sequencer/arpeggiator step relative to the BPM. VALUE works with both internal and external clock sources. The following table lists the values:

Name	Tempo	Timing Division
Half	BPM/2	Half note
Qtr	BPM	Quarter note
8th	BPM x 2	Eighth note
8th D	BPM x 2	Eighth note, dot
8th S	BPM x 2	Eighth note, swing timing
8th T	BPM x 3	Eighth note triplets
16th	BPM x 4	Sixteenth note
16th S	BPM x 4	Sixteenth note, full swing timing
16th T	BPM x 6	Sixteenth note triplets
32nd	BPM x 8	Thirty-second note

Master Volume/Program Volume

The master output level of the OB-6 is controlled by the front-panel MASTER VOLUME knob in the OUTPUT section. In addition, the volume of an individual program can be set with the PRGM VOL knob in same section. This is useful for ensuring that your sounds have roughly the same volume from program to program. Unison sounds in particular can be very loud compared to other programs.

OUTPUT

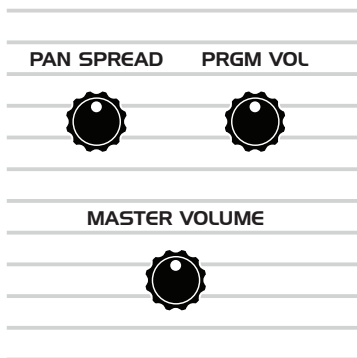

The Output section

To set the volume of an individual program:

1. Choose a program.
2. In the OUTPUT section, turn the PRGM VOL knob to set its volume.
3. Save the program. (See “Saving a Program” on page 4.)



MIDI volume can also influence the overall volume of the OB-6 if you are controlling it from an external MIDI source.

Pan Spread

Pan Spread pans audio in the stereo field individually per voice. Set to 0, all voices are panned to the center. As you turn the PAN SPREAD knob up, the audio in each voice is gradually moved away from the center by greater amounts. Every other voice goes in a different direction, left or right. This creates a broader stereo field while playing..

Transpose

The UP and DOWN buttons in the TRANSPOSE section transpose the keyboard up or down in octaves. The LED indicates the current keyboard transposition state. Transposing the keyboard also changes the MIDI note numbers of the keys so that MIDI notes sent are also transposed. Transpose settings are global and are not saved with individual programs.

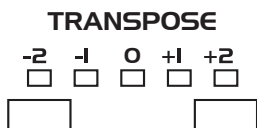

The Transpose controls

Hold

When HOLD is on, any notes played will continue to play until HOLD is turned off. When used in conjunction with the Arpeggiator, notes are latched on and replaced by any new note(s) struck. If HOLD is on and at least one key continuously held down, any new notes played are added to the arpeggio.



The Hold button

Portamento

Portamento causes the pitch of a note to glide up or down from the pitch of the previously played note. Portamento is turned on and off using the PORTAMENTO switch, but the RATE must also be set. If the PORTAMENTO button is on, but RATE AMOUNT is set to 0, PORTAMENTO has no effect.

RATE



PORTAMENTO

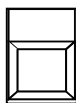

The Portamento controls

There are four modes that determine how portamento behaves.

Fixed Rate (F_r): The time to transition between notes varies with the interval between the notes; the greater the interval, the longer the transition time. The portamento rate is fixed. This is the default portamento mode.

Fixed Rate A (F_rA): The same as Fixed Rate, but portamento is only applied when playing legato. That is, portamento only occurs when a note is held until the next note is played. This effectively allows portamento to be turned on and off from the keyboard.

Fixed Time (F_t): Portamento is set to a fixed time, regardless of the interval between notes.

Fixed Time A (F_tA): The same as Fixed Time, but portamento only occurs when playing legato.

To select a portamento mode:

1. Press and hold the PORTAMENTO switch. The numeric display shows the currently selected portamento mode.
2. To select a different mode, continue to hold down the PORTAMENTO switch then press the BANK/DECREMENT and TENS/INCREMENT switches to step through the other choices.
3. When finished, release the PORTAMENTO switch.

Unison

When UNISON is on, the OB-6 functions like a monophonic synthesizer in that only 1 note can be played at a time. However, that one note can be powered by as many as six voices, depending on how many you choose to use. With up to 12 oscillators powering a single note (2 oscillators per voice x 6 voices), you can create some very dense, speaker-rattling sounds.



If you want to create an ultra heavy synth bass, try using Unison!

Unison gives you control over not only how many voices to stack, but also the amount of detuning (with the DETUNE knob) between the oscillators, and what note gets priority if you happen to play more than one note on the keyboard. (This is called the key assign mode or *note priority*. See “Key Assign Modes” on page 50 for details.)

When Unison is enabled, the DETUNE knob not only detunes the unison voices but also spreads them out in the stereo field. If an odd number of voices are stacked, one voice is placed in the center of the stereo field with the other voices spread right and left. The higher the DETUNE setting, the wider the stereo spread.

DETUNE



UNISON



The Unison button

To use Unison:

1. Press and hold the UNISON switch.
2. With the Unison switch held down, use the BANK/DECREMENT and TENS/INCREMENT switches to choose the number of voices to stack, then release the Unison switch.
3. To detune the oscillators, use the DETUNE knob.

Using Chord Memory

Unison has another useful feature: chord memory. Instead of assigning voices to a single note, hold down a chord on the keyboard and press the Unison switch. The OB-6 memorizes the notes of the chord. Single notes played on the keyboard will then trigger all notes of the stored chord, transposing them as you play up or down the keyboard. Try using this feature to create powerful chord stabs and hits.

If you save a program that uses chord memory, the chord is saved with the program. “[HD]” will then appear as a choice if you step through voice stacking options using the BANKS/DECREMENT and TENS/INCREMENT buttons while holding down UNISON.



If low-note priority is chosen in Global settings, the note that you play corresponds to the lowest note of the chord voicing. Changing the Key Assign Mode to high-note priority will make the note that you play correspond to the highest note in the chord voicing.

To use chord memory:

1. Hold down a chord on the keyboard (6 notes maximum).
2. Press the UNISON switch. The chord voicing is memorized. Play a few notes to listen to the result.
3. If you save the program, the unison chord memory is saved with it.

To clear chord memory:

1. Turn off Unison.
2. Hold down a single note.
3. Press the UNISON button.
4. Save the program again.

Key Assign Modes

Key Assign (sometimes called note priority) determines what note has priority when more than one note is played on the keyboard or via MIDI:

- Low-Note Priority ($L\bar{N}$) is most common in vintage synths and is often used for playing trills by holding a note and repeatedly tapping a lower note.
- Low Retrigger ($L\bar{R}$) causes the envelopes to be retriggered with each keystroke.
- High Note ($H\bar{N}$) and High Retrigger ($H\bar{R}$) are similar to the low note settings, except that the highest note is given priority.
- Last Note ($L\bar{N5}$) and Last Retrigger ($L\bar{R}$) give priority to the last note played.

To choose the Key Assign mode:

1. Press and hold KEY MODE. The numeric display shows the currently selected mode.
2. To select a different mode, continue to hold down the KEY MODE switch then press the BANK/DECREMENT and TENS/INCREMENT switches to step through the other choices.
3. Release the KEY MODE switch when you're finished.



Key Assign settings are only relevant to Unison mode. They do not affect polyphonic playback.

KEY MODE **DETUNE**



The KEY MODE button

Write

The WRITE button saves the currently active program. Saving a program overwrites a previously saved program.

The OB-6 contains a total of 1000 programs. 500 are permanent and 500 can be overwritten. Banks 0-4 are User Banks that can be overwritten. Banks 5-9 are Factory Banks that are permanent. You can edit the programs of either bank, but you can only save them to Banks 0-4. As shipped from the factory, presets 000-499 are identical to 500-999.

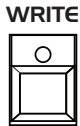

The Write button

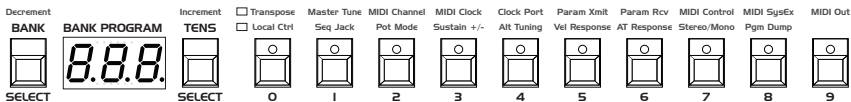

Program bank, tens, and number selectors

To save a program to the same preset location:

1. Press the WRITE button. Its LED begins blinking.
2. Press a PROGRAM SELECTOR button (0-9) to specify the “ones” digit of the program.
3. The WRITE button LED stops blinking and the program is saved.

To save a program to a different bank location:

1. Press the WRITE button. Its LED begins blinking.
2. Hold down the BANK button then press a PROGRAM SELECTOR button (0-9) to specify the “hundreds” bank of the program. You can only save to Banks 0-4.
3. Hold down the TENS button then press a PROGRAM SELECTOR button (0-9) to specify the “tens” digit of the program.
4. Press a PROGRAM SELECTOR button (0-9) to specify the “ones” digit of the program.
5. The WRITE button LED stops blinking and the program is saved.

Canceling Save

Sometimes you may want to cancel saving a program before you commit.

To cancel the Save process before you commit:

- If the WRITE button LED is flashing, press it again. The LED stops flashing and saving is canceled. You can return to editing if you want.

Comparing Before You Save

Before writing a program to a new location, it's a good idea to listen to the program in the target location to make sure you really want to overwrite it.

To evaluate a program before you overwrite it:

1. Get ready to save by pressing the WRITE button. It starts flashing.
2. Press the GLOBAL button. Both LEDs on the button light up, indicating COMPARE mode.
3. Use the program buttons to navigate to the sound you want to compare and play the keyboard to hear the sound.
4. To disable the compare function and go back to the edited sound, turn off the GLOBAL button. Programs can't be written while in compare mode.
5. If you want to save the edited sound, the WRITE button is still flashing and ready to save, so enter a location with the program buttons. The sound is saved.
6. Alternatively, if you want to cancel saving and continue editing, press the WRITE button. It stops flashing and saving is canceled.

Globals

Global settings are parameters that affect all programs. These include settings such as Master Tune, MIDI Channel, MIDI Clock, and others. Global parameters are printed in two rows the program number switches (0 - 9). Press the GLOBALS button once to access the top row. Press it twice to access the bottom row. For details on the various Global parameters, see “Global Settings” on page 10.

GLOBALS



The Globals button

To change a Global setting:

1. Press the GLOBALS button. Pressing it once accesses the top row of Global parameters. Pressing it twice accesses the top row of Global parameters. The LED indicates which row is active.
2. Press the PROGRAM SELECTOR button that corresponds to the Global parameter you want to change.
3. Use the BANK/DECREMENT and TENS/INCREMENT buttons to step through the available settings until you reach the one you want.
4. When finished, press GLOBALS again to exit.



Pressing the GLOBALS button three times in a row saves the current program as the default program that appears when you turn on the OB-6.

Manual

The MANUAL switch toggles “live panel” mode on and off. In live panel mode the OB-6 ignores the currently active preset and reverts to the current front-panel settings of its knobs and switches. In other words, what you see on the front panel is what you hear. This is a great mode for learning, experimentation, and instant gratification.

MANUAL

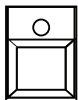

The Manual button

To enter live panel mode:

- Press the MANUAL button to toggle it on. The OB-6 is now in live panel mode. What you see on the front panel is what you hear. Note that you can't change programs or banks with MANUAL on.

To return to preset mode:

- Press the MANUAL button again to toggle it off. The LED is off. The current program is what you hear.



Be aware when entering live panel mode that the current settings of the OB-6 knobs and switches may be such that no sound is produced. This could be because the Mixer levels are all set to zero, or some other reason. See *Appendix B: Troubleshooting and Support* for a checklist that can help you identify the cause.

Pitch and Mod Wheels

The OB-6 has a spring-loaded Pitch wheel and a Mod wheel. You can use these controls to enhance live performance by bending notes and adding modulation in real time as you play.

In the same way that guitar players use note bends and vibrato to give their playing expressiveness and character, these two controls can really help you define your sound as a performer and take you beyond just playing notes on the keyboard.

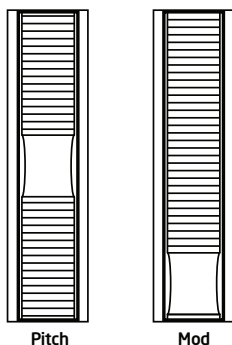

The Pitch and Modulation wheels

Pitch Wheel

You can set a range in semitones for the Pitch wheel, depending on your playing preference. The range is up to 12 semitones (1 octave). Many musicians use a range of 2 semitones (a whole step) since this is the bend range of many acoustic instruments. For guitar whammy bar effects, you may wish to set a wider range.

To set the pitch bend range:

1. Press and hold the **WHL RANGE** button.
2. With the button still held down, use the **BANK/DECREMENT** and **TENS/INCREMENT** switches to choose the number of semitones (up to 12) for the pitch bend range, then release the **WHL RANGE** button.

Modulation Wheel

The Mod wheel controls the amount of modulation applied to any destinations chosen in the LOW-FREQUENCY OSCILLATOR section. This allows you to “perform” LFO modulation in real time by moving the Mod wheel. This is a great way to add expressiveness to a sound or performance.

To choose a modulation destination for the Mod wheel:

1. In the LOW-FREQUENCY OSCILLATOR section, choose a modulation destination as well as a SHAPE and FREQUENCY for the LFO. (See “Low Frequency Oscillators” on page 34 for more details.)
2. To apply modulation only when using the Mod wheel, set the INITIAL AMT knob to zero. (Turning this knob up will apply LFO modulation continuously — not just when the Mod wheel is used.)



Many programs use the Mod wheel to add vibrato. In this case, vco 1 and vco 2 are enabled as modulation destinations in the LOW-FREQUENCY OSCILLATOR section. This adds vibrato when you push the mod wheel forward. Set the INITIAL AMT knob to zero to apply vibrato only when using the Mod wheel.

Aftertouch

Aftertouch is a performance feature that allows you to add modulation to a sound by applying additional pressure to a key after the key is already down. The greater the pressure applied, the more modulation is applied. The OB-6 provides *monophonic* (or “channel”) aftertouch, which means that applying pressure to any key within a chord will apply modulation to *all* notes currently held.

The Aftertouch section lets you choose the amount of modulation applied using aftertouch and which parameters are modulated (oscillator frequency, filter frequency, etc.). You can set either a positive or negative amount.

For example, if you select the filter cutoff frequency as destination (FILT FREQ), set a *positive* amount of aftertouch, then press the keys harder, the filter cutoff frequency will increase, making the filter open wider and the sound become brighter.

Conversely, if you select the filter frequency as destination, set a *negative* amount of aftertouch, then press the keys harder, the filter cutoff frequency will be lowered, making the filter close more and the sound become more muted.



The OB-6 provides four different aftertouch response settings for your convenience. The default setting provides a linear response. To choose a different response curve, use the **AT RESPONSE** button in the **GLOBALS** section. See page 14 for more details.

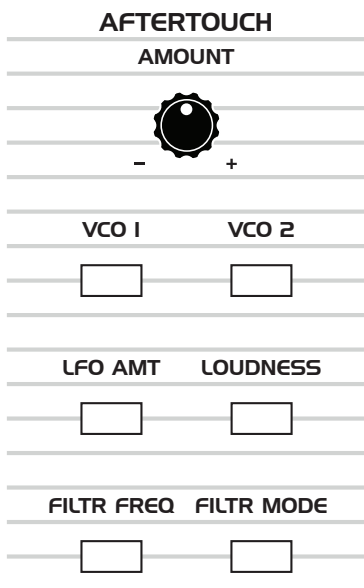

The Aftertouch controls

Amount: Selects the amount of aftertouch applied to a selected destination. Positive **AMOUNT** settings apply positive amounts of modulation. Negative **AMOUNT** settings apply negative amounts of modulation.

VCO 1: Selects Oscillator 1 frequency as an aftertouch modulation destination. With a positive **AMOUNT** setting, pressing the keys harder will shift the Oscillator 1 pitch upward. With a negative **AMOUNT** setting, pressing the keys harder will shift the Oscillator 1 pitch downward.

VCO 2: Selects Oscillator 2 frequency as an aftertouch modulation destination. With a positive `AMOUNT` setting, pressing the keys harder will shift the Oscillator 2 pitch upward. With a negative `AMOUNT` setting, pressing the keys harder will shift the Oscillator 2 pitch downward.

LFO Amount: Selects the `LFO AMOUNT` parameter as an aftertouch modulation destination. With a positive `AMOUNT` setting, pressing the keys harder will increase the amount of LFO modulation to any destination selected in the `LOW-FREQUENCY OSCILLATOR` section. With a negative `AMOUNT` setting, pressing the keys harder will increase the amount of LFO modulation — with the LFO waveform inverted.

Loudness: Selects Amplitude as an aftertouch modulation destination. With a positive `AMOUNT` setting, pressing the keys harder will increase the volume of a sound. With a negative `AMOUNT` setting, pressing the keys harder will decrease the volume of a sound.



If the Loudness Envelope's `AMOUNT` is set to full, positive amounts of `LOUDNESS` aftertouch will have no effect since the VCA is already at its maximum output level.

Filtr Freq: Selects the filter cutoff frequency as a modulation destination. With a positive `AMOUNT` setting, pressing the keys harder will open the filter wider and make a sound become brighter. With a negative `AMOUNT` setting, pressing the keys harder will close the filter more and make a sound more muted.

Filtr Mode: Selects the Filter Mode as a modulation destination. With a positive `AMOUNT` setting, pressing the keys harder will move smoothly between low-pass, notch, and high-pass filter modes.

Exporting Programs and Banks

You can use the PGM DUMP command in the GLOBALS section to transmit the current program, bank, or all banks in SysEx format via the selected MIDI port. This allows you to save your programs so that you can share them or archive them.

To export a program or bank as a SysEx file over MIDI:

1. Press the GLOBALS button once (this enables the upper set of parameters) then press program selector 8 to select the MIDI SYSEX command.
2. Use the BANK/DECREMENT and TENS/INCREMENT buttons to select the appropriate MIDI port — MIDI (*i i d*) or USB (*U5b*).
3. Press GLOBALS a second time (this enables the lower set of parameters) then press program selector 8 to select the PGM DUMP command. The WRITE button begins flashing.
4. Use the BANK/DECREMENT and TENS/INCREMENT buttons to select the desired option — program (*P r 0*), tens (*t E n*), bank (*b A n*), user banks (*U5r*), all (*A L L*).
5. Press WRITE. The program or bank is exported.



Dumped programs will load back into the same bank and program location in memory when received by the OB-6 via MIDI.

Calibrating the OB-6

The OB-6 is calibrated at the factory. Controls such as the pitch and mod wheels shouldn't require re-calibration. However, because its oscillators and filters are voltage controlled and can be affected by extremes of temperature, you may need to use the built-in calibration function to tune them occasionally.

How and When to Calibrate the Oscillators and Filters

The first time you use the OB-6, please run its built-in oscillator and filter calibration procedure. Let it warm up for several minutes and come to its normal operating temperature before doing so.

Repeat the calibration procedure as needed over the next few days of use. The OB-6 learns the range of temperatures at your location and will keep itself in tune over this range.

Later, if you use the OB-6 in a different environment that is measurably warmer or cooler (on stage, in an air-conditioned studio, and so on) run the calibration procedure again.

To calibrate the oscillators and filters:

1. Hold down the `MANUAL` button and press `0`.
2. The front panel LEDs and display begin flashing as the OB-6 performs its auto-calibration procedure. Don't turn off the power while it's doing this.
3. When finished, the front panel controls will return to normal and you can play the OB-6 again.

Calibrating the Pitch and Mod Wheels

In general, the Pitch and Mod wheels shouldn't require re-calibration. However, if you experience what seems like a persistent problem with either of them, the OB-6 has built-in auto-calibration procedure that you can use to remedy the problem.

To calibrate the Pitch and Mod wheel's low position:

1. Rotate and hold both wheels in their low position.
2. Hold down the `MANUAL` button and press 7.

To calibrate the Pitch wheel's center position:

- With the Pitch wheel centered, hold down the `MANUAL` button and press 8.

To calibrate the Pitch and Mod wheel's high position:

1. Rotate and hold both wheels in their high position.
2. Hold down the `MANUAL` button and press 9.

Resetting the Global Parameters

If you're trying to track down a problem, it's sometimes a good idea to reset the Global parameters to their defaults. This is a quick way to make sure that the OB-6 returns to its factory settings.

To reset all Global parameters to their default settings:

- Hold down the `GLOBAL` button and press `WRITE`.

Using USB

The OB-6's USB 2.0 port enables bidirectional MIDI communication with a computer. A MIDI interface and MIDI cables are not necessary, just a USB cable. The OB-6 is a Class Compliant USB device. That means it does not require any additional drivers to be installed to communicate with a Mac or Windows computer. The OB-6 transmits and receives MIDI data via USB, but does not transmit audio.



MIDI In and USB should not be used at the same time, as overlapping messages from different sources may cause the OB-6 to respond unpredictably. MIDI Out and USB can be used at the same time and transmit the same data.

USB Notes

Under Mac OS X, “OB-6 Keyboard” will appear as a MIDI port when connected via USB and can be configured using the Mac’s Audio MIDI Setup utility (typically found in Applications/Utilities).

Under Windows, the first time the OB-6 is connected via USB, the “Found new hardware” alert appears and it is automatically installed as “OB-6 Keyboard.”

In Windows, if you unplug the USB cable and plug it back in while a program has the OB-6 port open, you may have to resync. That usually means going to the OB-6 Keyboard Properties — in the Windows Device Manager under “Sound, video, and game controllers” — and clicking OK. If *OB-6 Keyboard* is no longer listed in the Device Manager, power the OB-6 down and back up again while it is connected via USB. It should be detected on power up.

Appendix A: Alternative Tunings

By default, the OB-6 is set to standard, chromatic western tuning. Additionally it supports up to 16 additional alternative tunings, which you can access using the `ALT TUNING` button in the `GLOBALS` section.

From the factory, the OB-6 ships with 16 preset alternative tunings ranging from Equal temperament to Indonesian Gamelan tunings. If you want, you can replace these with other tunings that you can find on the Internet. These must be in SysEx format. You can download them into the OB-6 using SysEx Librarian for Mac or MIDI-OX for Windows.

Here are descriptions of the default alternative tunings:

`nor` **(Normal) 12 Tone Equal Temperament (non-erasable)**

The default Western tuning, based on the twelfth root of two.

1. Harmonic Series

MIDI notes 36-95 reflect harmonics 2 through 60 based on the fundamental of A = 27.5 Hz. The low C on a standard 5 octave keyboard acts as the root note (55Hz), and the harmonics play upwards from there. The remaining keys above and below the 5 octave range are filled with the same intervals as Carlos' Harmonic 12 Tone that follows.

2. Carlos Harmonic Twelve Tone

Wendy Carlos' twelve note scale based on octave-repeating harmonics. A = 1/1 (440 Hz). 1/1 17/16 9/8 19/16 5/4 21/16 11/8 3/2 13/8 27/16 7/4 15/8

3. Meantone Temperament

An early tempered tuning, with better thirds than 12ET. Sounds best in the key of C. Use this to add an authentic touch to performances of early Baroque music. C=1/1 (260 Hz)

4. 1/4 Tone Equal Temperament

24 notes per octave, equally spaced $24\sqrt[24]{2}$ intervals. Mexican composer Julian Carillo used this for custom-built pianos in the early 20th century.

5. 19 Tone Equal Temperament

19 notes per octave ($19\sqrt{2}$) offering better thirds than 12 ET, a better overall compromise if you can figure out the keyboard patterns.

6. 31 Tone Equal Temperament

Many people consider $31\sqrt{2}$ to offer the best compromise towards just intonation in an equal temperament, but it can get very tricky to keep track of the intervals.

7. Pythagorean C

One of the earliest tuning systems known from history, the Pythagorean scale is constructed from an upward series of pure fifths ($3/2$) transposed down into a single octave. The tuning works well for monophonic melodies against fifth drones, but has a very narrow palate of good chords to choose from. C=1/1 (261.625 Hz)

1/1 256/243 9/8 32/27 81/64 4/3 729/512 3/2 128/81 27/16 16/9 243/128

8. Just Intonation in A with 7-limit Tritone at D#

A rather vanilla 5-limit small interval JI, except for a single $7/5$ tritone at D#, which offers some nice possibilities for rotating around bluesy sevenths. A=1/1 (440 Hz) 1/1 16/15 9/8 6/5 5/4 7/5 3/2 8/5 5/3 9/5 15/8

9. 3-5 Lattice in A

A pure 3 and 5-limit tuning which resolves to very symmetrical derived relationships between notes. A=1/1 (440 Hz)

1/1 16/15 10/9 6/5 5/4 4/3 64/45 3/2 8/5 5/3 16/9 15/8

10. 3-7 Lattice in A

A pure 3 and 7-limit tuning which resolves to very symmetrical derived relationships between notes. Some of the intervals are very close together, offering several choices for the same nominal chords. A=1/1 (440 Hz)

1/1 9/8 8/7 7/6 9/7 21/16 4/3 3/2 32/21 12/7 7/4 63/32

11. Other Music 7-Limit Black Keys in C

Created by the group Other Music for their homemade gamelan, this offers a wide range of interesting chords and modes. C=1/1 (261.625 Hz)

1/1 15/14 9/8 7/6 5/4 4/3 7/5 3/2 14/9 5/3 7/4 15/8

12. Dan Schmidt Pelog/Slendro

Created for the Berkeley Gamelan group, this tuning fits an Indonesian-style heptatonic Pelog on the white keys and pentatonic Slendro on the black keys, with B and Bb acting as 1/1 for their respective modes. Note that some of the notes will have the same frequency. By tuning the 1/1 to 60 Hz, Dan found a creative way to incorporate the inevitable line hum into his scale. Bb, B = 1/1 (60 Hz)

1/1 1/1 9/8 7/6 5/4 4/3 11/8 3/2 3/2 7/4 7/4 15/8

13. Yamaha Just Major C

When Yamaha decided to put preset microtunings into their FM synth product line, they selected this and the following tuning as representative just intonations. As such, they became the de-facto introduction to JI for many people. Just Major gives preferential treatment to major thirds on the sharps, and a good fourth relative to the second. C= 1/1 (261.625)

1/1 16/15 9/8 6/5 5/4 4/3 45/32 3/2 8/5 5/3 16/9 15/8

14. Yamaha Just Minor C

Similar to Yamaha's preset Just Major, the Just Minor gives preferential treatment to minor thirds on the sharps, and has a good fifth relative to the second. C= 1/1 (261.625) 1/1 25/24 10/9 6/5 5/4 4/3 45/32 3/2 8/5 5/3 16/9 15/8

15. Harry Partch 11-limit 43 Note Just Intonation

One of the pioneers of modern microtonal composition, Partch built a unique orchestra with this tuning during the first half of the 20th century, to perform his own compositions. The large number of intervals in this very dense scale offers a full vocabulary of expressive chords and complex key changes. The narrow spacing also allows fixed-pitched instruments like marimbas and organs to perform glissando-like passages. G = 1/1 (392 Hz, MIDI note 67)

1/1 81/80 33/32 21/20 16/15 12/11 11/10 10/9 9/8 8/7 7/6 32/27 6/5 11/9
5/4 14/11 9/7 21/16 4/3 27/20 11/8 7/5 10/7 16/11 40/27 3/2 32/21 14/9
11/7 8/5 18/11 5/3 27/16 12/7 7/4 16/9 9/5 20/11 11/6 15/8 40/21 64/33
160/81

16. Arabic 12-Tone

A 12-tone approximation of an Arabic scale, which appears in some electronic keyboards designed for use with Arabic music. Not a JI scale, nor equal tempered. These are the intervals in Cents relative to C:

60 = Cents 0.

61 = Cents +151.

62 = Cents +204.

63 = Cents +294.

64 = Cents +355.

65 = Cents +498.

66 = Cents +649.

67 = Cents +702.

68 = Cents +853.

69 = Cents +906.

70 = Cents +996.

71 = Cents +1057.

72 = Cents +1200

Appendix B: Troubleshooting and Support

Troubleshooting

If you're experiencing problems or unexpected behavior from your OB-6, here are a few typical scenarios and their solutions:

If the OB-6 isn't producing sound in live panel mode:

1. Enable live panel mode by pressing the **MANUAL** button.
2. Initialize a basic program by holding the **MANUAL** button and pressing the **WRITE** button.
3. If the problem is still there, return the instrument to live panel mode again and check all parameters to make sure they are at non-zero values. These parameters include:
 - VCO 1 & 2 pitch
 - VCO 1 & 2 mixer levels
 - Program volume
 - Master volume
 - Set the Loudness Envelope **AMOUNT** to max. Use a fast envelope with Sustain at max.
 - Set VCO 1 & 2 to sawtooth
 - Set filter cutoff to max
 - Check all other parameters by physically changing them.

If the sequencer or arpeggiator has stopped running:

- Check the MIDI Clock setting in the Globals to ensure the OB-6 is set to **OUT** or, if set to **IN** or **SLAVE THRU**, make sure the OB-6 is receiving MIDI clock.

If some of the programs sound different than usual:

- Check the Mod Wheel position. The Mod Wheel can do more than just add vibrato. Also, check the Clock settings in the Global menu to ensure the OB-6 is set to **OUT** or, if set to **IN** or **SLAVE THRU**, make sure the OB-6 is receiving MIDI clock.

If there is a ground hum in the audio output:

- USB can cause ground loops, so try to resolve any grounding issues between the computer and the OB-6. Or use MIDI, which is opto-isolated.

If the OB-6 is behaving erratically.

- This is almost always caused by a MIDI data loop. Make sure that any MIDI Thru functionality is turned off on the MIDI interface/hardware or in the MIDI software application. Disconnect all the OB-6's MIDI connections—MIDI and USB cables—and see if the problem persists. You can also monitor the MIDI traffic with MIDI Monitor (Mac OS) or MIDI-OX (Windows) to see if the OB-6 is being overrun with duplicate messages.

If the OB-6 doesn't seem to respond to its controls:

- Make sure Local Control is on in the Global settings.

If MIDI System Exclusive data is not transmitted/received:

- Make sure that the MIDI SysEx setting in the Global settings is set to USB OR MIDI depending on which you are using to transmit or receive MIDI messages.

If the OB-6 plays out of tune:

- Check Transpose and Master Tune parameters in the Global settings. If they seem correct, you may need to retune the oscillators. See “Calibrating the Prophet-6” on page 56. If this doesn't help, recalibrate the pitch and mod wheels. “Calibrating the Pitch and Mod Wheels” on page 57.

If the pitch or mod wheel doesn't go full range:

- Recalibrate the pitch and mod wheels. See “Calibrating the Pitch and Mod Wheels” on page 57.

If the filter sounds strange or out of tune:

- You may need to retune the filters. See “Calibrating the Prophet-6” on page 56.

If the OS Fails to Load Correctly When You Update:

- The OB-6 is equipped with a MIDI bootloader, which will allow you to reload the OS in the event the you accidentally “brick” your synth (permanently freeze it) while updating its OS.

To restore your OB-6 if it is frozen.

1. Power on the OB-6 while holding the Write switch to enter bootloader mode. You'll see an animation in the Effects Parameter 1 display.
2. Use a MIDI cable (not USB) to transmit the new OS to your synth. You must use a standard MIDI cable for this. USB MIDI doesn't work in bootloader mode.
3. As the OS loads, you will see the main display count backwards from 999. When it gets to 0, another countdown will begin between the main display and the FX Parameter 1 display. Do not power down until this countdown has finished. The OB-6 will restart itself when it is done.

Contacting Technical Support

If you are still having a problem with the OB-6, contact Technical Support at support@davesmithinstruments.com. Please include your OB-6's serial number, the version of the operating system (displayed in the Global screen), and the purchase date.



If you have not already reset the Global parameters and run the calibration routines (see Troubleshooting), you should do it before contacting Technical Support. It's probably the first thing they'll ask you to do.

Warranty Repair

Dave Smith Instruments warrants that the OB-6 will be free from defects in materials and/or workmanship for 1 year from the date of purchase. Please register your product online at www.davesmithinstruments.com to establish the date of purchase. (This is not a requirement for warranty service, but it will help expedite the process.)

Please contact support@davesmithinstruments.com to determine the best course of action for getting your OB-6 repaired. For your own protection, as well as ours, please do not return any product to Dave Smith Instruments without a return authorization (RA) number. To issue an RA number, Technical Support needs:

- Your name
- Your return address
- Your email address
- A phone number where you can be reached
- Your OB-6's serial number
- The date of purchase and where purchased

If you need to return your instrument for repair, you are responsible for getting it to DSI. We highly recommend insuring it and packing in the original packaging. Damage resulting from shipping a product with insufficient packaging is not covered by warranty.

Appendix C: MIDI Implementation

The OB-6 receives MIDI data according to the settings you have chosen in the GLOBAL settings. In addition, there is interaction between some of the Program parameters that determine the overall response of OB-6 to MIDI data. Following are the Global parameters that affect response to MIDI:

MIDI Channel: *ALL, 1... 16*—Selects which MIDI channel to send and receive data, 1 to 16. All receives on all 16 channels.

MIDI Clock: Sets the OB-6's ability to send and receive MIDI clock messages:

- *OFF*: MIDI Clock is neither sent nor received
- *OUT*: MIDI Clock is sent, but not received
- *IN*: MIDI Clock is received, but not sent
- Slave Thru (*IN-OUT*): MIDI Clock is received and passed to MIDI Out
- In, No Start/Stop (*IN55*): Receives MIDI Clock but does not respond to MIDI Start or Stop command.



When set to IN or SLAVE THRU, if no MIDI clock is present at the selected input, the arpeggiator and sequencer will not function.

Clock Port: *in, USB*—Sets the port(s), MIDI or USB, by which MIDI clock signals are received.

Param Xmit: *OFF, CC, NR*—Changes to the values of front panel controls are transmitted via MIDI as Continuous Controllers (*CC*) or Non-registered Parameter Number (*NR*). Transmission of parameters can also be turned off.



NRPNS are the preferred method of parameter transmission, since they cover the complete range of all parameters, while CCs are limited to a range of 128.

Param Rcv: *OFF, CC, NR*—Sets the method by which parameter changes are received via MIDI. As with transmission, NRPNS are the preferred method.

MIDI Control: *OFF, On*—When On, the synth will respond to MIDI controllers, including Pitch Wheel, Mod Wheel, Pedal, Volume.

MIDI Sysex: *MIDI, USB*— When set to MIDI (*MIDI*) it will receive and transmit them using the MIDI ports/cables When set to USB it will receive and transmit them using the USB port/cable. MIDI SysEx messages are used when sending and receiving a variety of data including, programs, alternative tunings, system updates, and more.

MIDI Out: *MIDI, USB*—Sets the port by which MIDI data will be transmitted (MIDI or USB)..

MIDI Messages

System Real-Time Messages

Status	Description
1111 1000	MIDI Timing Clock

Received Channel Messages

Status	Second	Third	Description
1000 nnnn	0kkkkkkk	0vvvvvvv	Note Off. Velocity is ignored
1001 nnnn	0kkkkkkk	0vvvvvvv	Note On. Note off if vvvvvvv = 0
1010 nnnn	0kkkkkkk	0vvvvvvv	Polyphonic Key Pressure
1011 nnnn	0vvvvvvv	0vvvvvvv	Control Change; see "Received Controller Messages"
1100 nnnn	0ppppppp		Program change, 0-99 for Programs 1-100 within current Bank
1101 nnnn	0vvvvvvv		Channel Pressure
1110 nnnn	0vvvvvvv	0vvvvvvv	Pitch Bend LS Byte then MS Byte

Notes: 0kkkkkkk
 nnnn
 0vvvvvvv

Note number 0 — 127
 Channel number 0 to 15 (MIDI channel 1-16).
 Ignored if MIDI channel set to ALL
 Value

Received Controller Messages

Status	Second	Third	Description
1011 nnnn	1	0vvvvvvv	Mod Wheel: directly assignable controller
1011 nnnn	4	0vvvvvvv	Foot Controller: directly assignable controller
1011 nnnn	7	0vvvvvvv	Volume: Combined with Master Volume and Voice Volume
1011 nnnn	74	0vvvvvvv	Brightness: Added to filter cutoff frequency
1011 nnnn	32	0vvvvvvv	Bank Select: 0 - 4 select user banks 0 - 4; 5 - 9 select factory banks 0 - 4; others ignored
1011 nnnn	64	0vvvvvvv	Damper pedal: Holds envelopes in Sustain if 0100 0000 or higher
1011 nnnn	123	0vvvvvvv	All Notes Off: Clear all MIDI notes
1011 nnnn	121	0vvvvvvv	Reset All Controllers: Clears all MIDI controllers to 0, MIDI volume to maximum

See sections below for additional Continuous Controller (CC) and Non-registered Parameter Number (NRPN) messages received.

Transmitted Channel Messages

Status	Second	Third	Description
1000 nnnn	0kkkkkkk	0000000	Note Off.
1001 nnnn	0kkkkkkk	0vvvvvvv	Note On.
1011 nnnn	0vvvvvvv	0vvvvvvv	Control Change; see "Transmitted Controller Messages"
1100 nnnn	0ppppppp		Program change, 0-99 for Programs 00-99 within current Bank
1101 nnnn	0vvvvvvv		Channel Pressure
1110 nnnn	0vvvvvvv	0vvvvvvv	Pitch Bend LS Byte then MS Byte

Notes: 0kkkkkkk Note number 0 — 127
 nnnn Channel number 0 to 15 (MIDI channel 1-16).
 Ignored if MIDI channel set to ALL
 0vvvvvvv Value

Transmitted Controller Messages

Status	Second	Third	Description
1011 nnnn	0000 0001	0vvvvvv	Mod Wheel
1011 nnnn	0000 0100	0vvvvvv	Foot Controller: When assigned to Pedal 1 or Pedal 2
1011 nnnn	0000 0111	0vvvvvv	Volume: When assigned to Pedal 1 or Pedal 2
1011 nnnn	0100 1010	0vvvvvv	Brightness: When assigned to Pedal 1 or Pedal 2
1011 nnnn	0010 0000	0vvvvvv	Bank Select: 0 - 9
1011 nnnn	0100 0000	0vvvvvv	Damper pedal: Sends 0 if off, 0111 1111 when on
1011 nnnn	0000 0111	0vvvvvv	Volume knob

See sections that follow for additional Continuous Controller (CC) and Non-registered Parameter Number (NRPN) messages transmitted.

Additional Continuous Controllers Transmitted/Received

The following table details how MIDI Continuous Controllers (CCs) are mapped to OB-6 controls. They are transmitted when Param Xmit is set to CC, and recognized/received when MIDI Rev Receive is set to CC.

CC#	Param
0	Bank Select MSB
1	Mod Wheel
3	BPM
4	Foot Controller
5	Portamento Time
6	Data Entry MSB
7	MIDI Volume
8	Sub Octave Level
9	Distortion Amount
38	Data Entry LSB
39	Volume LSB
40	VCA Env Amt
41	VCA Env Vel Amt
43	VCA Env Attack
44	VCA Env Decay
45	VCA Env Sustain
46	VCA Env Release
47	Filter Env Amt
50	Filter Env Attack
51	Filter Env Decay
52	Filter Env Sustain
53	Filter Env Release
58	Arp On/Off
59	Arp Mode
60	Arp Octave
62	Arp Clock Division
64	Damper Pedal
65	Portamento On/Off
67	Osc 1 Freq
69	Osc 1 Level
70	Osc 1 Shape
71	Osc 1 Pulse Width

CC#	Param
74	Brightness
75	Osc 2 Freq
76	Osc 2 Detune
77	Osc 2 Level
78	Osc 2 Shape
79	Osc 2 Pulse Width
96	Data Increment
97	Data Decrement
98	NRPN Param LSB
99	NRPN Param MSB
100	RPN Param LSB
101	RPN Param MSB
102	Filter Freq
103	Filter Resonance
104	Filter Key Amt
105	Filter Vel On/Off
106	Filter Mode
107	Band Pass On/Off
120	All Sound Off
121	Reset Controllers
122	Local Control On/Off
123	All Notes Off
124	Omni Mode Off
125	Omni Mode On
126	Mono Mode On
127	Poly Mode On

NRPN Messages

The Non-Registered Parameter Number (NRPN) MIDI messages are used to transmit and receive both global and program parameters. They are transmitted when MIDI Parameter Send is set to NRPN in Global, and received when MIDI Parameter Receive is set to NRPN in Global.

The messages are handled in standard MIDI format using the NRPN CC commands in running status byte format. Below is the format used for transmitting a NRPN parameter.

Transmitted NRPN Messages

Status	Description
1011 nnnn	Control Change
0110 0011	NRPN parameter number MSB CC
0vvv vvvv	Parameter Number MSB
0110 0010	NRPN parameter number LSB CC
0vvv vvvv	Parameter Number LSB
0000 0110	NRPN parameter value MSB CC
0vvv vvvv	Parameter value MSB
0010 0110	NRPN parameter value LSB CC
0vvv vvvv	Parameter value LSB

The parameter number can be found in the two tables below, one for Global parameters, and the other for Program parameters. The parameter numbers and the parameter values are broken into two 7-bit bytes for MIDI transmission; the LSB has the seven least-significant bits, and the MSB has the seven most-significant bits, though in most cases the MSB will be zero or one, and never more than two.

When receiving an NRPN, all messages do not necessarily need to be transmitted, since the synth will track the most recent NRPN number, though it is usually good practice to send the entire message above.

Once an NRPN is selected, the synth will also respond to NRPN Data Increment and Decrement commands, which some controllers utilize. Finally, it responds to one RPN (Registered Parameter Number) command, the RPN/NRPN Reset command, which can be handy for resetting the currently selected parameter to a known state.

Received NRPN Messages

Status	Second	Third	Description
1011 nnnn	0110 0011	0vvvvvvv	NRPN parameter number MSB CC
1011 nnnn	0110 0010	0vvvvvvv	NRPN parameter number LSB CC
1011 nnnn	0000 0110	0vvvvvvv	NRPN parameter value MSB CC
1011 nnnn	0010 0110	0vvvvvvv	NRPN parameter value LSB CC
1011 nnnn	0110 0000	0xxxxxxx	NRPN parameter value Increment
1011 nnnn	0110 0001	0xxxxxxx	NRPN parameter value Decrement
1011 nnnn	0010 0101	01111111	RPN parameter number MSB CC - Reset NRPN parameter number (when both MSB and LSB received)
1011 nnnn	0010 0100	01111111	RPN parameter number LSB CC - Reset NRPN parameter number (when both MSB and LSB received)

Global Parameter Data

The table shows the Global data sent and received on global parameter dumps, and corresponding NRPN number when sent/received individually.

NRPN	Range	Description
1024	0-100	Master Fine Tune
1025	0-24	Master Coarse Tune
1026	0-16	MIDI Channel 0 = All
1027	0-3	MIDI Clock Mode 0 = Off 1 = Master 2 = Slave 3 = Slave Thru
1028	0-1	MIDI Clock Port 0 = MIDI Port 1 = USB
1029	0-2	MIDI Param Send* 0 = NRPN 1 = CC 2 = Off
1030	0-2	MIDI Param Receive† 0 = NRPN 1 = CC 2 = Off
1031	0-1	MIDI Control Enable 0 = Off 1 = On
1032	0-1	MIDI SysEx Enable 0 = Off 1 = On

NRPN	Range	Description
1033	0-3	MIDI Out Select 0 = Off 1 = MIDI 2 = USB 3 = MIDI+USB
1035	0-1	Local Control* 0 = Off 1 = On
1037	0-2	Pot Mode 0 = Relative 1 = PassThru 2 = Jump
1039	0-3	Seq Jack 0 = normal 1 = trigger 2 = gate 3 = trigger+gate
1040	0-3	Sustain Polarity 0 = normally open 1 = normally closed 2 = Sustain Normally Open/ Sequencer Normally Closed 3 = Sustain Normally Closed/ Sequencer Normally Open
1041	0-3	Velocity Response
1042	0-3	Aftertouch Response
1043	0-1	Mono/Stereo 0 = Stereo 1 = Mono
1044	0-16	Alt Tuning

*Controller received, but not transmitted.

†Controller transmitted, but ignored when received.

Program Parameter Data

The following table lists OB-6's program parameters.

NRPN	Value	Description
0	0-60	Osc 1 Freq
1	0-1	Osc 1 Sync
2	0-127	Osc 1 Level
3	0-255	Osc 1 Shape
4	0-255	Osc 1 Pulse Width
5	0-60	Osc 2 Freq
6	0-254	Osc 2 Freq Fine
7	0-127	Osc 2 Level
8	0-254	Osc 2 Shape
9	0-255	Osc 2 Pulse Width
10	0-1	Osc 2 Low Freq
11	0-1	Osc 2 Key On/Off
27	0-127	Osc 1 Sub Level
28	0 -3	Portamento Mode
29	0-1	Portamento On/Off
30	0-127	Portamento Rate
31	0-12	Pbend Range
32	0-127	Noise Level
33	0-127	Detune
45	0-164	Filter Freq
46	0-255	Filter Res
47	0-2	Filter Key Amt
48	0-1	Filter Vel On
49	0-1	Filter mode
50	0-1	Filter Normal - Bandpass
62	0-127	Voice Volume
63	0-127	Pan Spread
64	0-127	Distortion Amt
66	0-127	VCA Env Amt
67	0-127	VCA Env Attack
68	0-127	VCA Env Decay

NRPN	Value	Description
69	0-127	VCA Env Sustain
70	0-127	VCA Env Release
71	0-1	VCA Env Vel On/Off
77	0-254	Filter Env Amt
78	0-127	Filter Env Attack
79	0-127	Filter Env Decay
80	0-127	Filter Env Sustain
81	0-127	Filter Env Release
88	0-254	LFO Freq
89	0-255	LFO Initial Amt
90	0-4	LFO Shape
91	0-1	LFO Sync
93	0-1	LFO Freq 1 Dest On/Off
94	0-1	LFO Freq 2 Dest On/Off
95	0-1	LFO PW 1, 2 Dest On/Off
96	0-1	LFO Amp Dest On/Off,
97	0-1	LFO Filter Mode Dest On/Off
98	0-1	LFO Amp Dest On/Off
109	0-254	Pressure Amt
110	0-1	Pressure Freq 1 Dest On/Off
111	0-1	Pressure Freq 2 Dest On/Off
112	0-1	Pressure Low-pass Dest On/Off
113	0-1	Pressure Filter Mode Dest On/Off
114	0-1	Pressure VCA Dest On/Off
115	0-1	Pressure LFO Amt Dest On/Off

NRPN	Value	Description
119	0-5	FX 1 Type
120	0-127	FX 1 Mix
121	0-255	FX 1 Param 1
122	0-127	FX 1 Param 2
123	0-1	FX 1 Sync
127	0-9	FX 2 Type
128	0-127	FX 2 Mix
129	0-255	FX 2 Param 1
130	0-127	FX 2 Param 2
131	0-1	FX 2 Sync
135	0-1	FX On/Off
143	0-254	XMod Filter Env Amt
144	0-254	XMod Osc 2 Amt
145	0-1	XMod Freq 1 Dest On/Off
146	0-1	XMod Shape 1 Dest On/Off
147	0-1	XMod PW 1 Dest On/Off
148	0-1	XMod Filter Dest On/Off
149	0-1	XMod Filter Mode Dest On/Off
150	0-1	XMod Norm-Band-pass Dest On/Off,
156	0-1	Unison On/Off
157	0-6	Unison Mode
158	0-5	Key Mode
160	0-1	Arp On/Off
161	0-4	Arp mode
162	0-2	Arp Range
163	0-9	Arp Tim Sig
167	30-250	BPM
236-255	32 - 125	Name 0-19
256-319	12-108	Seq Step 1-64 Note 1
320-383	0-127	Seq Step 1-64 Vel 1
384-447	12-108	Seq Step 1-64 Note 2

NRPN	Value	Description
448-511	0-127	Seq Step 1-64 Vel 2
512-575	12-108	Seq Step 1-64 Note 3
576-639	0-127	Seq Step 1-64 Vel 3
640-703	12-108	Seq Step 1-64 Note 4
704-767	0-127	Seq Step 1-64 Vel 4
768-831	12-108	Seq Step 1-64 Note 5
832-895	0-127	Seq Step 1-64 Vel 5
896-959	12-108	Seq Step 1-64 Note 6
960-1023	0-127	Seq Step 1-64 Vel 6
1024	0-100	Tuning Fine
1025	0-24	Tuning Coarse
1026	0-16	MIDI Channel
1027	0-4	MIDI Clock
1028	0-1	MIDI Clock Port
1029	0-2	MIDI Param Send
1030	0-2	MIDI Param Receive
1031	0-1	MIDI MIDI Control
1032	0-1	MIDI SysEx Control
1033	0-3	MIDI Out
1035	0-1	Local Control
1037	0-2	Pot Mode
1039	0-3	Seq Jack
1040	0-3	Sustain Polarity
1041	0-3	Velocity Response
1042	0-3	At Response
1043	0-1	Stereo Mono
1044	0-16	Alt Tuning
1089	0-127	Seq Transpose

Control NRPN Data

The following table lists the OB-6's control NRPN data. It is received and transmitted but not saved as part of a program.

NRPN	Value	Description
1088	0-1	Seq Play/Stop
16256	0-1	Seq Rec On/Off

Sysex Messages

Universal System Exclusive Message (Device Inquiry)

Status	Description
1111 0000	System Exclusive (SysEx)
0111 1110	Non-realtime message
0vvv vvv	If MIDI channel is set to 1 - 16, 0vvvvvvv must match (unless MIDI Channel = ALL); always responds if 0vvvvvvv = 0111 1111.
0000 0110	Inquiry Message
0000 0001	Inquiry Request
1111 0111	End of Exclusive (EOX)

The OB-6 responds with:

Status	Description
1111 0000	System Exclusive (SysEx)
0111 1110	Non-realtime message
0vvv vvv	If MIDI Channel = ALL, 0vvvvvvv = 0111 1111. Otherwise 0vvvvvvv = Channel Number 0 - 15.
0000 0110	Inquiry Message
0000 0010	Inquiry Reply
0000 0001	DSI ID
0010 1101	OB-6 ID (Family LS)
0000 0001	Family MS
0000 0000	Family Member LS
0000 0000	Family Member MS
0jjj nnnn	Main Software version: jjj - Minor rev; nnnn - Major rev
1111 0111	End of Exclusive (EOX)

Request Program Dump

Status	Description
1111 0000	System Exclusive (SysEx)
0000 0001	DSI ID
0010 1110	OB-6 ID
0000 0101	Request Program Transmit
0000 00vv	Bank Number, 0 - 9
0vvv vvvv	Program Number, 0 - 99
1111 0111	End of Exclusive (EOX)

The OB-6 will respond by sending out the Program Data in the format described below in *Program Data Dump*.

Request Program Edit Buffer Dump

Status	Description
1111 0000	System Exclusive (SysEx)
0000 0001	DSI ID
0010 1110	OB-6 ID
0000 0110	Request Program Edit Buffer Transmit
1111 0111	End of Exclusive (EOX)

The OB-6 will respond by sending out the current Program edit buffer in the format described below in Program Edit Buffer Data Dump.

Request Global Parameter Dump

Status	Description
1111 0000	System Exclusive (SysEx)
0000 0001	DSI ID
0010 1110	OB-6 ID
0000 1110	Request Global Parameter Transmit
1111 0111	End of Exclusive (EOX)

The OB-6 will respond by sending out the current values of Global Parameters in the format described in *Global Parameters Data Dump*.

Program Data Dump

Status	Description
1111 0000	System Exclusive (SysEx)
0000 0001	DSI ID
0010 1110	OB-6 ID
0000 0010	Program Data
0000 00vv	Bank Number: 0 - 9
0vvv vvvv	Program Number: 0 - 99
0vvv vvvv	1024 bytes expanded to 1171 MIDI bytes in "packed MS bit" format
1111 0111	End of Exclusive (EOX)

Program Edit Buffer Data Dump

Status	Description
1111 0000	System Exclusive (SysEx)
0000 0001	DSI ID
0010 1110	OB-6 ID
0000 0011	Edit Buffer Data
0vvv vvvv	1024 bytes expanded to 1171 MIDI bytes in "packed MS bit" format
1111 0111	End of Exclusive (EOX)

Global Parameters Data Dump

Value	Description
1111 0000	System Exclusive (SysEx)
0000 0001	DSI ID
0010 1110	OB-6 ID
0000 1111	Main Parameter Data
0vvv vvvv	50 nibbles (LS then MS) for 25 Global parameters
1111 0111	End of Exclusive (EOX)



The Global Parameters Data Dump is not recognized when received; it is only transmitted when requested. NRPN messages are used to change Globals.

Packed Data Format

Data is packed in 8 byte “packets”, with the MS bit stripped from 7 parameter bytes, and packed into an eighth byte, which is sent at the start of the 8 byte packet.

Example:

Input Data

```
1 A7 A6 A5 A4 A3 A2 A1 A0
2 B7 B6 B5 B4 B3 B2 B1 B0
3 C7 C6 C5 C4 C3 C2 C1 C0
4 D7 D6 D5 D4 D3 D2 D1 D0
5 E7 E6 E5 E4 E3 E2 E1 E0
6 F7 F6 F5 F4 F3 F2 F1 F0
7 G7 G6 G5 G4 G3 G2 G1 G0
```

Packed MIDI data

```
1 00 G7 F7 E7 D7 C7 B7 A7
2 00 A6 A5 A4 A3 A2 A1 A0
3 00 B6 B5 B4 B3 B2 B1 B0
4 00 C6 C5 C4 C3 C2 C1 C0
5 00 D6 D5 D4 D3 D2 D1 D0
6 00 E6 E5 E4 E3 E2 E1 E0
7 00 F6 F5 F4 F3 F2 F1 F0
8 00 G6 G5 G4 G3 G2 G1 G0
```

This explains why it takes 1171 MIDI bytes to transmit 1024 Program data bytes.

Dave Smith Instruments LLC
1527 Stockton Street, 3rd Floor
San Francisco, CA 94133
USA

www.davesmithinstruments.com

DSI-10139R